

SERVICE MANUAL

marantz

model 2245

Stereophonic Receiver

SPECIFICATIONS

Audio Circuits:

Rated continuous (RMS) power output per channel, both channels operating simultaneously, 20 Hz to 20,000 Hz	45 Watts at 4 and 8 ohms 25 Watts at 16 ohms
Comparable Total Music Power (IHF)	135 Watts at 8 ohms
High-level hum and noise (ref. 40W at 8 ohms)	-80 dB
Phono hum and noise	1.5 μ V equivalent input
Dynamic range (phono input to tape recording output)	96 dB
I. M. Distortion (SMPTE), at rated power	0.3%
Distortion decreases as output is lowered	
Total Harmonic Distortion, at rated power	0.3% Maximum
Distortion decreases as output is lowered	
Power Bandwidth (IHF) for 0.3% THD	7 Hz to 70,000 Hz
Damping Factor (ref. 8 ohms)	Greater than 45
Frequency Response	
Through phono	± 1 dB
Input Sensitivity (for 40W at 8 ohms)	
High-level	180 mV
Phono (1,000 Hz)	1.8 mV
Input Impedance	
High-level	100,000 ohms
Phono	47,000 ohms
Channel Separation 20 Hz to 20,000 Hz	35 dB Minimum

FM Sections:

IHF Usable Sensitivity	2.3 μ V
Selectivity	60 dB
Noise Quieting	-55 dB at 5 μ V -60 dB at 10 μ V -65 dB at 50 μ V
Total Harmonic Distortion, 400 Hz, 100% Mod.	(Mono) 0.2% (Stereo) 0.4%
Frequency Response (ref. 75 μ sec. de-emphasis)	± 1 dB 50 Hz to 15 KHz
Stereo Separation	1,000 Hz 40 dB
Sub-Carrier (38 kHz) Suppression	60 dB

General:

Power Requirements	100/120/200/220/240V AC 50 to 60 Hz
At rated output, both channels operating	310 Watts
Idling Power (Volume Control at zero)	34 Watts
Dimensions	
Panel Width	17 ²¹ / ₆₄ Inches
Panel Height	5 ²⁵ / ₆₄ Inches
Depth	14 Inches
Weight	
Unit alone	34.5 lbs
Packed for shipment	44.5 lbs

* These specifications and external designs may be changed for improvement without advance notice.

TABLE OF CONTENTS

SECTION	PAGE
Introduction	1
Service Notes	1
AM Tuner	1
FM Tuner	2
Phono and Tone Amplifiers	4
Power Amplifier	5
Power Protection Circuit	5
Speaker Protector Relay Circuit	5
Suggestions for Trouble Shooting of Power Amplifier	6
Voltage Conversion	6
Test Equipment Required for Servicing	8
AM Alignment Procedure	9
FM Alignment Procedure	9
STEREO Separation Alignment	9
Muting Circuit Alignment	10
Audio Adjustment	10
Parts List	21
Specifications	29

LIST OF ILLUSTRATIONS

FIGURE	PAGE
1. Remove the Terminal Cover	6
2. Voltage Conversion Chart	7
3. Lissajou Figure on Oscilloscope	11
4. Dial Stringing	11
5. Front Panel Adjustment and Component Locations	12
6. Main Chassis Component Locations (Top View)	12
7. Rear Panel Adjustment and Component Locations	13
8. Main Chassis Component Locations (Bottom View)	13
9. FM Front End Assembly P100 Component Locations	14
10. FM IF Amplifier Assembly P200 Component Locations	14
11. FM Detector Assembly P500 Component Locations	15
12. MPX Stereo Decoding Amplifier Assembly P300 Component Locations	15
13. Muting Control Amplifier Assembly P550 Component Locations	16
14. AM Tuner Unit Assembly P150 Component Locations	16
15. Phono Amplifier Assembly P700 Component Locations	17
16. Tone Amplifier Assembly P400 Component Locations	17
17. Power Amplifier Assembly P750 Component Locations	18
18. Regulated Power Supply and Protection Relay Circuit Assembly P800 Component Locations	19
19. Loudness, High and Low Filter and Muting Switch Unit Assembly P600 Component Locations	19
20. Schematic Diagram	20

INTRODUCTION

This service manual was prepared for use by Authorized Warranty Stations and contains service information for Marantz Model 2245 Stereophonic Receiver.

Servicing information and voltage data included in this manual are intended for use by the knowledgeable and experienced technician only. All instruction should be read carefully. No attempt should be made to proceed without a good understanding of the operation in the receiver.

The parts list furnish information by which replacement part may be ordered from the Marantz Company. A simple description is included for parts which can be usually be obtained through local suppliers.

1. Service Notes

As can be seen from the circuit diagram the chassis of Model 2245 consists of the following units. Each unit mounted on a printed circuit board is described within the square enclosed by a bold dotted line on the circuit diagram.

- | | |
|---|-----------------------------|
| 1. FM Front End | mounted on P.C. Board, P100 |
| 2. FM IF Amplifier | mounted on P.C. Board, P200 |
| 3. FM Detector | mounted on P.C. Board, P500 |
| 4. MPX Stereo Decoding Amplifier | mounted on P.C. Board, P300 |
| 5. Muting Control Amplifier | mounted on P.C. Board, P550 |
| 6. AM Tuner Unit | mounted on P.C. Board, P150 |
| 7. Phono Amplifier | mounted on P.C. Board, P700 |
| 8. Tone Amplifier | mounted on P.C. Board, P400 |
| 9. Power Amplifier | mounted on P.C. Board, P750 |
| 10. Regulated Power Supply and Protection Relay Circuit | mounted on P.C. Board, P800 |
| 11. Loudness, High and Low Filter, and Muting Switch Unit | mounted on P.C. Board, P600 |

2. AM Tuner

All components except Tuning capacitor and ferrite bar antenna are mounted on a printed circuit board P150.

The AM signals induced in a ferrite bar antenna are applied to the base of RF amplifier transistor H151 through a capacitor of C151 and amplified to the level required for overcoming the conversion noises, thus giving good S/N performance. The tuned circuits inserted in both out and input circuit of the RF amplifier assure very high image and spurious rejection performance. Thus amplified and selected AM signals are then applied to the base of converter transistor H152 through a coupling capacitor C156. While the local oscillator voltage is injected to the emitter of H152 through a capacitor C157. Both AM signals and oscillating voltage are mixed at the base-emitter junction and converted into 455KHz intermediate frequency. The resulting IF signal is applied to the first IF transformer L153 consisting of one ceramic filter and two tuned circuits.

The output of L153 is led to the transistor H153 which in turn apply its output to the transistor of next stage H154. The fully amplified IF output is then applied to the diode H157 to detect audible signal through the detector transformer L154. The detected audio signal is filtered and amplified and the final audio output is obtained from the collector of H155 and applied: one to the tape out jacks through monitor switch on the front panel and the other to the function rotary switch.

The DC component of the detected IF signal is used as a AGC voltage to control emitter current of H153 which in turn control the bias current of the RF amplifier through the resistor R179 and R151. A part of IF signal output is also applied to the diode H158 through a capacitor C167 and rectified to obtain DC current for energizing the AM signal strength meter M001.

Suggestions for AM Tuner Trouble Shooting

Check for broken AM bar antenna, next try to tune station by rotating fly-wheel tuning knob slowly and observe the AM signal strength meter whether it deflects or not. If the signal strength meter gives a deflection at several frequencies received, no failure may exist in the stages at least preceding final IF transformer L154. Next connect a oscilloscope to the pin terminal J162 or J157 and check for audio signals with the tuning meter deflected. If the signal strength meter does not deflect, check the local oscillator circuit. Normal oscillating voltage at the hot end of the oscillator tuning capacitor is about 2 or 3 volts, varying with tuning capacitor position. When measuring oscillating voltage use a RF VTVM, no circuit tester gives correct indication. If the local oscillator voltage is normal, check all voltage distribution in the AM circuits by using a DC VTVM and compare the measured values with those given in the schematic diagram.

3. FM Tuner

The FM Tuner section of Model 2245 is divided into five functional blocks: FM Front End, IF Amplifier, Detector, Muting Control and MPX Stereo Decoding Circuit.

FM signals induced by a FM antenna are led to FM antenna coil L101 through an attenuator switch and a Balun coil. These signals are then applied to the FET RF amplifier which in turn applies its output to the next FET Mixer H102 through the double tuned high selective circuits. The FET Mixer convert its input signal into 10.7MHz intermediate frequency and amplifies it at the same time. The H103 is a local oscillator and its output is injected into the source of the FET Mixer, the injection voltage is about 700mV. The 10,7MHz front end output is led to the next IF amplifier unit through a coaxial cable.

The IF amplifier unit consists of five stages of IF amplifier and one stage of AGC amplifier. Six pieces of ceramic filters are also used to obtain high selectivity four stages of symmetrical diode limiters are also employed for the best limiting characteristics, improved capture ratio and good AM suppression.

A part of FM Front End output is applied to the AGC amplifier H206 and rectified its output is fed back to the gate of FET RF amplifier to decrease the gain with increased signal strength.

The IF signal sufficiently amplified through every stage of IF amplifier is finally applied to the IC limiter on the Detector Unit. The detected audio output is led to the buffer amplifier H502 and its buffered output is led to; (a) noise amplifier H551 through resistor R551 and capacitor C551, (b) Quad Radial Jacks on the rear panel through resistor R564, (c) MPX stereo decoding circuit through R563.

The DC current caused at the third windings of the discriminator transformer is directly applied to the FM center tuning meter.

Audio Muting and Stereo mode auto-selecting circuit

The muting circuit consisting of all solid-state electrical switching has been incorporated in the Model 2245. Three inputs control the muting function. The first is related to signal strength, the second to the noise condition at the detector and the third is derived from the DC component of the detector output. These inputs are properly matrixed and gated to provide muting free from noise and transients.

The first input of DC voltage obtained by rectifying a part of IF output signal from the H205 is applied to the base of H306 and turns on it, if the IF output is greater than predetermined level (muting threshold level). When the H306 is turned on the H307 is turned off, allowing the emitter-collector resistance increasing and the collector voltage rises about 9V. The increased collector voltage increases the gate bias voltage and turns on the switching FET H308, decreasing the source-drain resistance to near zero ohm and allowing the audio signal applied to the source to flow to the center of 38KHz switching transformer through the source-drain path.

When the input signal is lower than predetermined level, the DC output obtained is small and can not turn on the H306, thus the H306 keeps its turn-off state and this makes H307 turn on, decreasing the collector voltage and turning off H308. Thus no audio signals can pass through the FET. This is the fundamental principle of the muting operation but for more elaborate muting operation the second and the third inputs are necessary.

The second input is used to protect the muting operation and MPX stereo beacon lamps from misoperation due to undesirable noises. The high frequency noises included in the detected audio signals are separated by a small capacitor C551 and amplified by the noise amplifier transistor H551 and its output is rectified by the two diodes. The rectified DC output is proportional to the noise components in the audio signals.

When there are excessive noises in the audio signals such as obtained with a station incorrectly tuned in, the rectified DC output turns on the transistor H522, decreasing the emitter-collector resistance to zero. This means the collector of H307 is short-circuited to the ground, therefore the H308 is turned off and any audio signals having excessive high frequency noises can not go through the FET's sourcedrain path.

The transistor H303 connected in series with the 19KHz pilot signal amplifier transistor H302 is also turned off (when the transistor H522 or H307 are turned on.) and no current flows in the H302, resulting in turning off the stereo beacon lamps. Thus misoperation due to undesirable noises is also avoided.

The third input is obtained from the FM discriminator circuit. The DC output so called "S" curve is applied to the gate of H558 through a resistor R523 and deviding network (R565 & R566). The DC output is zero with a station correctly tuned in, but will vary from negative to positive values or vice versa when the tuning point is deviated toward either plus or minus frequency from the correct tuning frequency.

When the DC output is increased to a greater level than that of predetermined, the increased source potential of H558 makes the transistor H561 turn on, and this makes the H306 turn off, H307 turn on, H308 turn off, H303 turn off (this means no 19KHz pilot signal is amplified and no stereo beacon is turned on.) When the DC output is increased to the negative predetermined level, the decreased source potential turns off the H559 which in turn makes the H560 turn on and the H306 is turned off. The subsequent changes are exactly the same as that just described above.

Thus when the tuning is shifted or deviated to the certain frequencies in which undesirable noisy side-audio signals are produced, both muting and 19KHz switching transistors are operated automatically and open the circuits.

With the station correctly tuned in, the bias current of the FET H558 is adjusted so that both transistor H560 and H561 are not turned on, giving no effect on the transistor H306.

MPX Stereo Decoding Circuit

The buffered and non-equalized audio signals are applied to the first amplifier H301 which serves as a tuned amplifier for the pilot signal in the composite signals and as a buffer amplifier for the audio signals. The amplified 19KHz pilot signal is led to the second 19KHz amplifier H302 and further amplified if switching transistor H303 is turned on by the controlling DC signal as described in the preceding chapter. The final 19KHz pilot signal is rectified by the doubler circuit consisting of the H315 and H316 to obtain synchronized 38KHz amplifier driving signal.

The H304 is the 38KHz tuned amplifier and supplies its output to the switching matrix circuit consisting of four diodes. While the composite signals are applied to the center tap of switching transformer 1/2 L302. The right and left stereo signals decoded by the switching circuit are led to the crosstalk cancelling amplifier which utilizes complementary configuration with NPN and PNP transistors through de-emphasis network consisting of C315 and R335, and C316 and R336. L305 is a low-pass filter networks having very sharp cut off characteristics and eliminates undesirable residual switching signals. Transistors H313 and H314 are buffer amplifiers and their outputs are led to the function switch.

Suggestion for Trouble Shooting of FM Tuner

Symptom: No FM Reception

First turn on the power switch and try to tune FM stations. Rotate the fly-wheel tuning knob slowly and observe the FM signal strength meter and FM center tuning meter. If the center tuning meter deflect at several frequencies received, the tuner circuits preceding the discriminator circuit may have no failure. If the signal strength meter deflect but no deflection is obtained on the center meter, there may be some defects around the detecting circuit consisting H501, L501, H503, H504, etc. When no reading is obtained in both meters, check FM local oscillator circuit, using a RF VTVM. The normal local oscillator voltage is one or two volts (rms) at the tuning capacitor, depending on the tuning capacitor position. If the local oscillator voltage is normal, next check all voltage distribution in the FM Front End and IF amplifier unit and compare them with those shown in the circuit diagram. When both meters deflect but no sound is obtained, check audio circuits, using high sensitive oscilloscope.

Symptom: No Stereo Separation

First check the MONO switch is in normal out position. Connect a FM RF signal generator output modulated by a stereo modulator to the rear FM antenna terminals, and check the stereo beacon is turned on or not. If not turned on, check for 19KHz pilot signal and 38KHz switching signal, using an oscilloscope.

4. Phono and Tone Amplifiers

Program source signals from the PHONO jacks on the rear panel are supplied to the input circuit of the Phono Amplifier through the selector switch and the output of the Phono Amplifier is applied to another section of the selector switch. This amplifier provides a gain of 40dB.

All signals selected by the function switch (S002-3F, 4F) are led to the balance and volume controls through the MONO switch.

Signals properly attenuated by the volume control are applied to the tone amplifier and subjected to the tone control networks such as bass, mid, treble control and high and low cut filters.

Thus controlled audio signals are then led to the PRE OUT jacks on the rear panel.

5. Power Amplifier

The signal from the tone amplifier is applied to the differential amplifier (base of H751) through the coupling capacitor C751. The differential amplifier provides very high input impedance and its collector output (H752) is applied to the base of H753 which in turn applies its output to the next stage; H756 through the network R766, C762 and R771, and to the H757 through the network R776, C763 and R772. The outputs of H756 and H757 are applied to the H758 and H757 respectively. H001 and H002 are power transistors used in complementary symmetry configuration and mounted on the heat sink.

To maintain overall amplifier stability and linearity, degenerative feed back is utilized throughout the amplifier. This feed back is also necessary to reduce distortion to within specified limit. The RC network R775 and C756 condition the feed back signal for the audio signals. R759 and C755 are also a feed back loop provided to obtain a stable zero DC off set voltage at the speaker output terminals. The R762 is a trimming resistor to adjust the DC off set voltage.

Dynamic bias is applied to the base of driver transistors H758 and H757. This dynamic bias circuit is comprised of H761, H760 and R763. This provides a variable base bias for driver transistors that automatically maintains the proper base voltage with temperature change. The temperature sensitive biasing components of the dynamic circuit are thermally coupled through a heatsink to the power amplifier transistors.

6. Power Protection Circuit

Protection circuit for the amplifier is provided by sensing resistor networks and two switching transistors. When the output transistors are over-driven, the current increase through the power output transistor causes an increased current flow through R789 (or R788) and the potential across the R789 will be increased. This increased voltage potential is applied to the base of H755 through the resistor R783 and turns on the H755. Since the collector of H755 is directly connected to the base of H757, this means that the base of H757 is bypassed to the ground through emitter-collector path of H755. Thus the input signal to the H757 is restricted to the value which maintains the operation of power transistor with in the safety area. A resistor network R777 and R781 also works as a sensing network. When the center voltage (collector voltage of power transistors) is excessively increased to a positive value by certain troubles, the voltage applied to the base of H755 makes the H755 turn on, making bypass circuit, and protects the power transistor. For the other half cycle of driving signal, the operating principle is applied provided.

7. Speaker Protector Relay Circuit

The speaker protection circuit consisting of H808, H809, H810, etc protects the speaker systems against any loud "pop" sound developed. This circuit is so designed that no sound is heard for the first three or five seconds after the power switch is turned on by the time constant circuit consisting of C807 and R816. This circuit also protects the speaker systems against some troubles due to DC off balance between the speaker system terminals by instantly operating the relay and cut off the speaker systems from the circuit. When DC off balance voltage (positive) is developed between speaker terminals by possible defects such as broken power transistor, short-circuits, or broken potentiometer R762, as the base of H808 is connected to the speaker terminal, the transistor H808 is turned on by this offset voltage developed and this makes the transistor H809 and H810 turns off, thus cutting off the relay and disconnecting the speaker from the output circuit. When negative offset voltage is developed, this voltage directly turns off the H809 and H810, thus speaker is cut off from the circuit and protected.

The circuit also protects the speaker systems from the possible damage when the amplifier is over-driven by very low frequencies such as 7 or lower cycles.

8. Suggestions for Trouble Shooting of Power Amplifier

8.1 Excessive Line Consumption

- Check for shorted rectifiers H005; also check C007 and C008.
- Check for shorted transistors H758 and H759, H001 and H002, or check H760. Check for open control R763, and bias diode H761. Check L004 for short.

CAUTION: BECAUSE THE DRIVER AND OUTPUT STAGES ARE DIRECT COUPLED COMPONENTS MAY FAIL AS A DIRECT RESULT OF AN INITIAL COMPONENT FAILURE. IF A SHORTED TRANSISTOR OR ZENER DIODE IS FOUND, OR CONTROL OR BIAS DIODE, BE SURE TO CHECK THE REMAINING DRIVER AND OUTPUT COMPONENTS FOR SHORT OR OPEN CIRCUIT BEFORE RE-ENERGIZING THE AMPLIFIER.

8.2 No Line Consumption or Zero Bias

- Check line cord, fuse, transistors H760, H001, H002, H003 and H004, bias diode H761.
- Check for open rectifier H005, or open L004.

8.3 No DC Balance

- Check R762 and Zener diodes H762 and H763.

9. Voltage Conversion

This model is equipped with a universal power transformer to permit operation at 100, 120, 200, 220 and 240V AC 50 to 60Hz.

To convert the Model 2245 to the required voltage perform the following steps:

- Remove the top cover.
- Remove the Transformer Wire Connection Terminal Cover, loosen two Cover mounting screws on the rear panel, see Fig. 1.
- Change the jumper wires as illustrated in Fig. 2 for the required AC voltage and replace the fuse as instructed.

CAUTION: DISCONNECT POWER SUPPLY CORD FROM AC OUTLET BEFORE CONVERTING VOLTAGE.

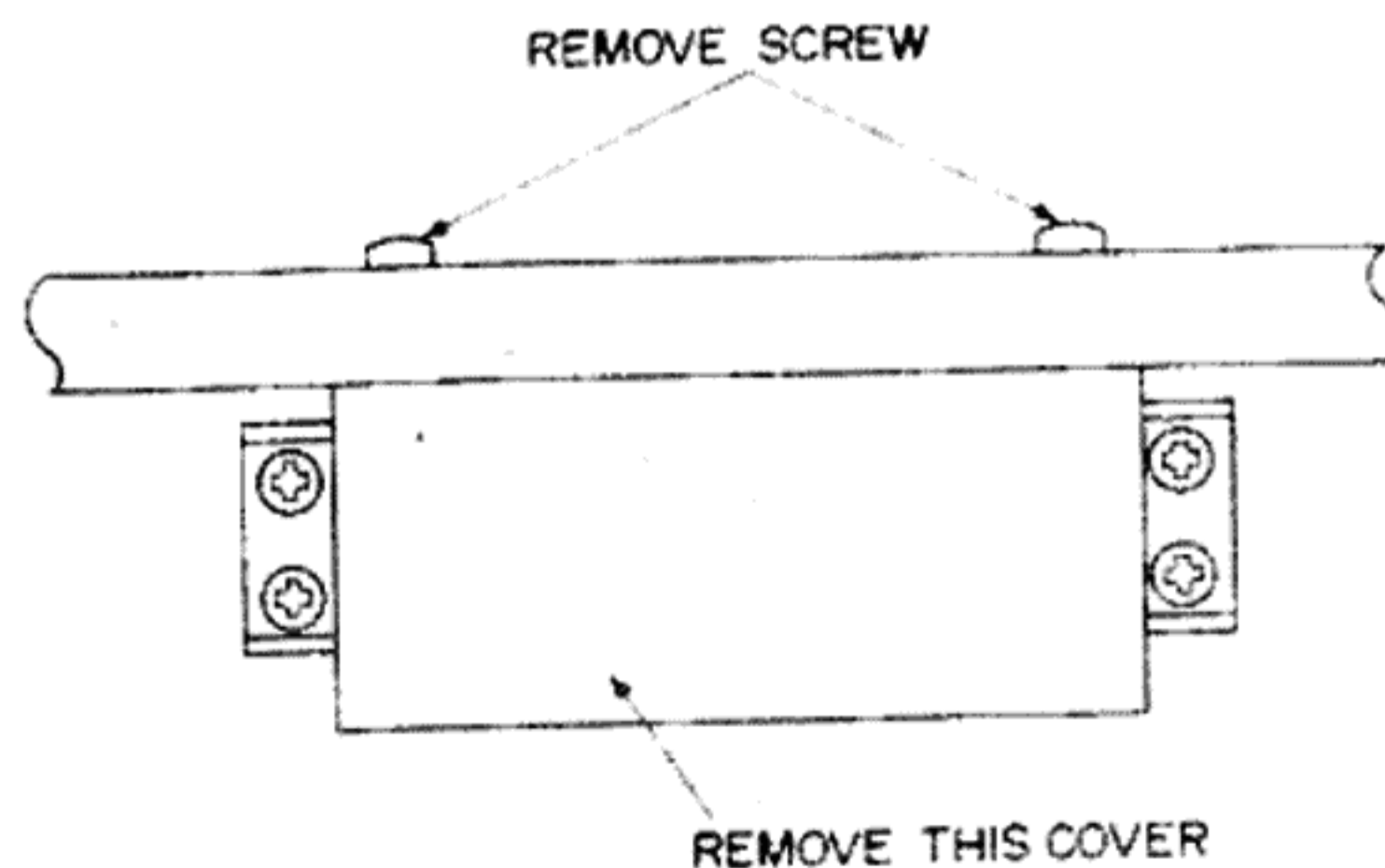
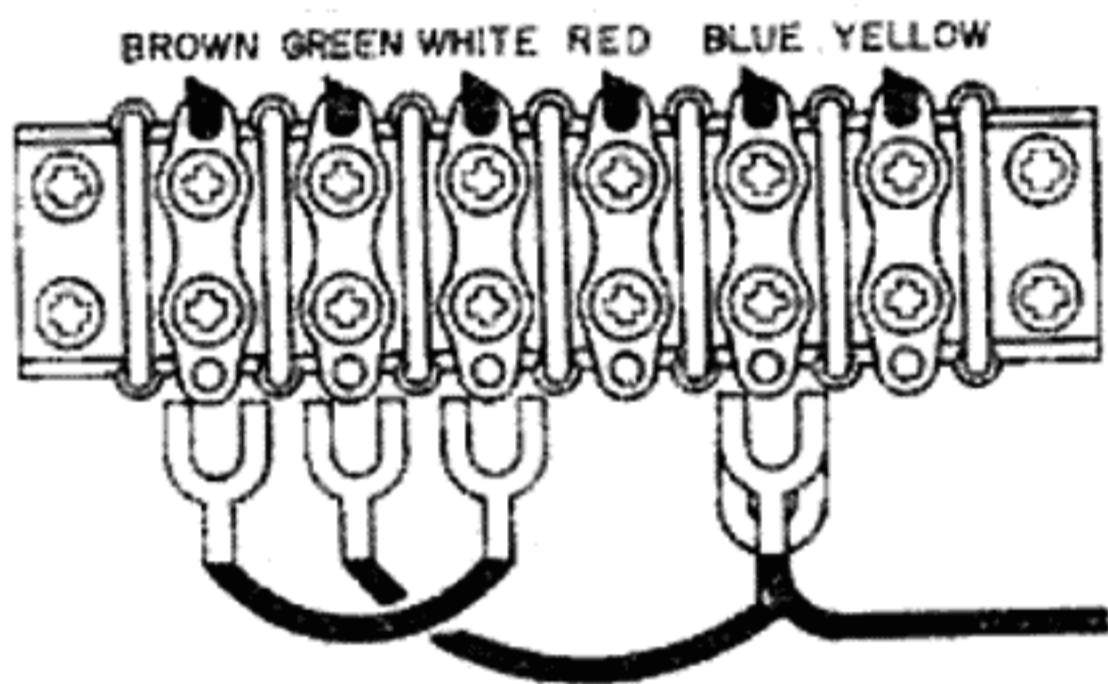
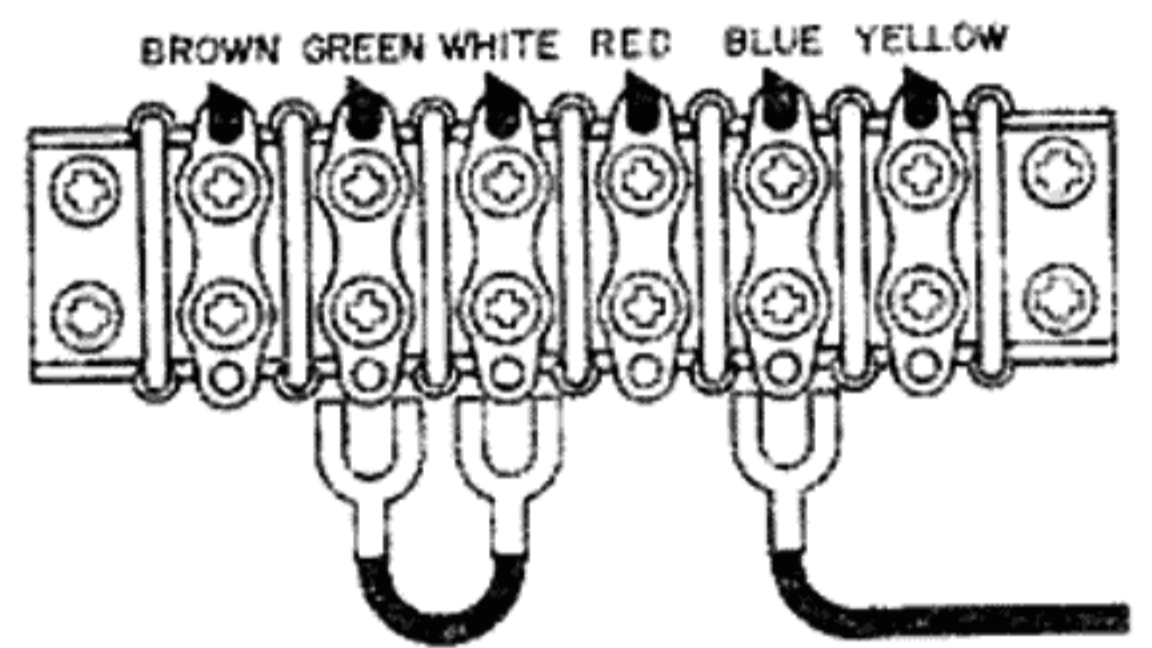

Figure 1. Remove the Terminal Cover

For 100 V Operation
(Use 4A Fuse)



For 200V Operation
(Use 3A Fuse)



For 120 V Operation
(Use 3A Fuse)

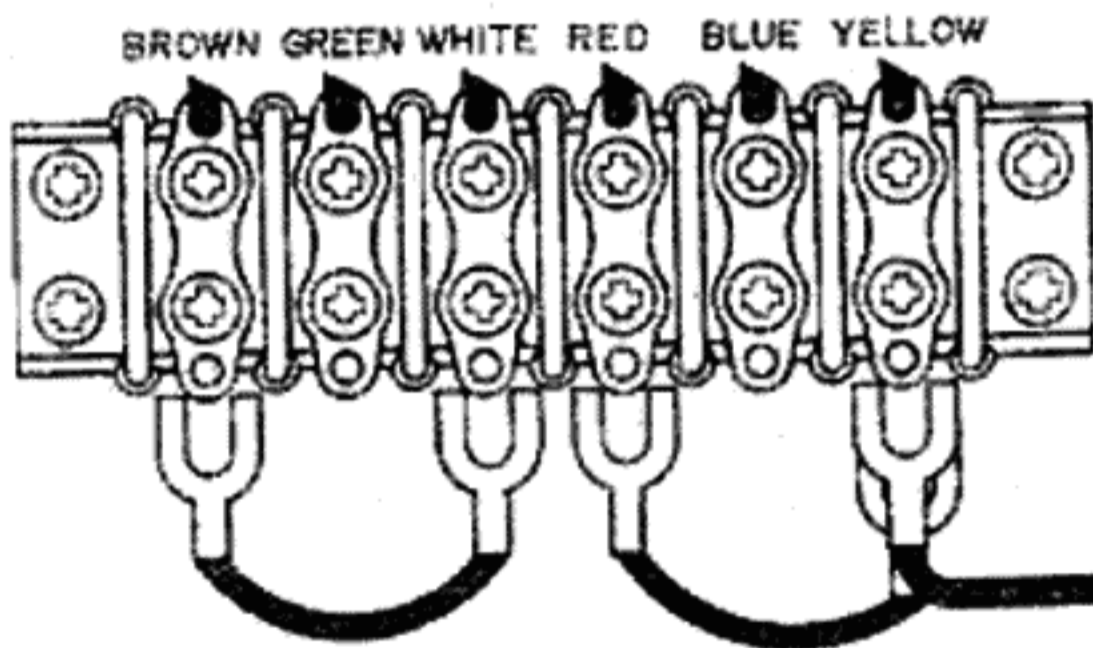

For 220V Operation
(Use 3A Fuse)

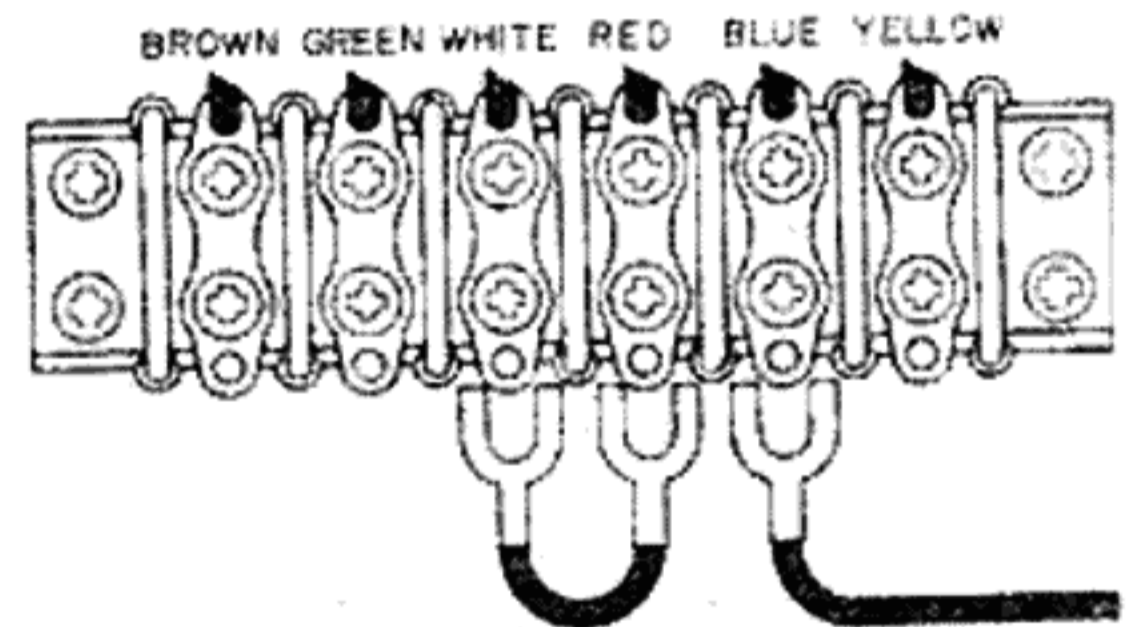

For 240V Operation
(Use 3A Fuse)

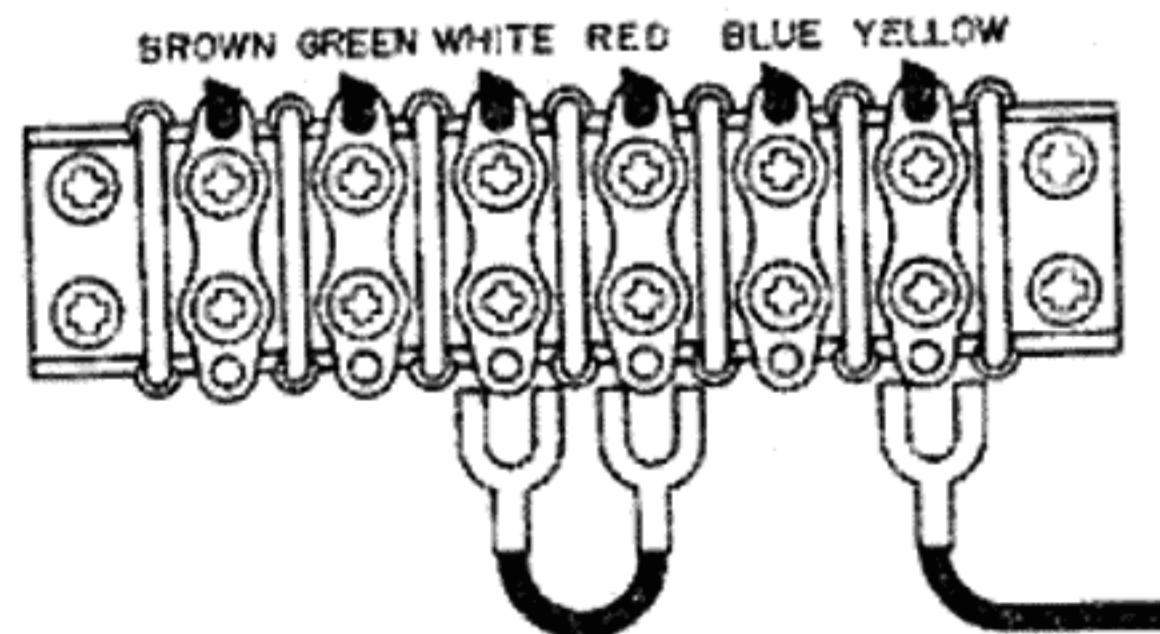

Figure 2. Voltage Conversion Chart

10. Test Equipment Required for Servicing

Table 1 lists the test equipment required for servicing the Model 2245 Receiver.

Item	Manufacturer and Model No.	Use
AM Signal Generator		Signal source for AM alignment
Test Loop		Used with AM Signal generator
FM Signal Generator	Less than 0.3% distortion	Signal source for FM alignment
Stereo Modulator	Less than 0.3% distortion	Stereo separation alignment and Trouble Shooting
Audio Oscillator	Weston Model CVO-100P, less than 0.02% residual distortion is required.	Sinewave and squarewave signal source.
Oscilloscope	High sensitivity with DC horizontal and vertical amplifiers.	Waveform analysis and trouble shooting, and ASO alignment.
VTVM	With AC, DC, RF range	Voltage measurements
Circuit Tester		Trouble Shooting
AC Wattmeter	Simpson, Model 390	Monitors primary power to Amplifier.
AC Ammeter	Commercial Grade (1-10A)	Monitors amplifier output under short circuit condition.
Line Voltmeter	Commercial Grade (0-15VAC)	Monitors potential of primary power to amplifier.
Variable Autotransformer (0-140VAC, 10 amps)	Powerstat, Model 116B	Adjusts level of primary power to amplifier.
Shorting Plug	Use phono plug with 600 ohm across center pin and shell.	Shorts amplifier input to eliminate noise pickup.
Output Load (8 ohms, 0.5%, 100W)	Commercial Grade	Provides 8-ohm load for amplifier output termination.
Output Load (4 ohms, 0.5%, 100W)	Commercial Grade	Provides 4-ohm load for amplifier output termination.

11. AM Alignment Procedure

AM IF Alignment

1. Connect a sweep generator to the J151 and an alignment scope to the J162.
2. Rotate each core of IF transformer L153 and L154 for maximum height and flat top symmetrical response.

AM Frequency Range and Tracking Alignment

1. Set AM signal generator to 525KHz. Turn the tuning capacitor fully closed (place the tuning pointer at the low end.) and adjust the oscillator coil L152 for maximum audio output.
2. Set the signal generator to 1650KHz. Place the tuning pointer in the high frequency end and adjust the oscillator trimmer on the oscillator tuning capacitor for maximum audio output.
3. Repeat the step 1 and 2 until no further adjustment is necessary.
4. Set the generator to 600KHz and tune the receiver to the same frequency and adjust a slug core of AM ferrite rod antenna and RF coil L151 for maximum output.
5. Set the generator to 1400KHz and tune the receiver to the same frequency and adjust both trimming capacitors of Antenna and RF tuned circuit for maximum output.
6. Repeat the step 4 and 5 until no further adjustment is necessary.

Note: During tracking alignment reduce the signal generator output as necessary to avoid AGC action.

12. FM Alignment Procedure

1. Connect a FM signal generator to the FM antenna terminals and a oscilloscope and an audio distortion analyzer to the tape output jacks on the rear panel.
2. Set the FM SG to 87.5 MHz and provide about 3 to 5 μ V. Place the tuning pointer at the low frequency end by rotating the tuning knob and adjust the core of oscillator coil L104 to obtain maximum audio output.
3. Set the FM SG to 108.5 MHz and provide about 3 to 5 μ V output. Rotate the tuning knob and place the tuning pointer at the high frequency end and adjust the trimming capacitor C106 for maximum output.
4. Repeat the step 2 and 3 until no further adjustment is necessary.
5. Set the FM SG to 90 MHz and tune the receiver to the same frequency. Decrease signal generator output until the audio output level decreases with the decreasing generator output. Adjust the antenna coil L101, RF coil L102, L103 and IF transformer L105 for minimum audio distortion.
6. Set the FM SG to 106 MHz and tune the receiver to the same frequency. Adjust the trimming capacitor C102, C104 and C105 for minimum distortion.
7. Adjust the secondary core (black) of discriminator transformer L501 so that the center tuning meter pointer indicates its center at no signal applied. Set the FM SG to 98 MHz and increase its output level to 1K μ V and tune the receiver to the same frequency so that the center tuning meter pointer indicates its center. Adjust the primary core (pink) of L501 for minimum distortion.

13. STEREO Separation Alignment

1. Set the FM SG to provide 1 kuV at 98 MHz. Tune the receiver to the same frequency so that the center tuning meter pointer indicates its center.
2. Modulate the FM SG with stereo composite signal consisting of only subchannel signal (of course a pilot signal must be included). Adjust the core of L301 for maximum audio output, then, modulate the signal generator with a stereo composite signal consisting of only L channel signal and again adjust the core of L301 for maximum audio output.
3. Adjust the trimming resistor R365 for maximum and same separation in both channels.

14. Muting Circuit Alignment

1. Connect a VTVM across the resistor R022 and adjust the resistor R022 until the meter reads 0.75 V DC at no signal.
2. Set the FM SG to provide 1 K μ V at 98 MHz and tune the receiver to the same frequency correctly.
3. Turn on MUTING pushswitch. Shift the FM signal generator frequency to plus and minus and note both plus and minus shifted frequencies at which undesirable audio side responses are muted out. Adjust the R022 so that the same shifted frequencies mute the undesirable side response.

15. Audio Adjustment

1. Voltage adjustment
Connect a DC voltmeter between pin terminal J802 and J803, and adjust the trimming resistor R809 for 35V DC.
2. Main Amplifier DC off-set alignment
Connect a DC voltmeter with 0.5 or 1V range between the speaker terminals and adjust the trimming resistor R762 for "zero" DC output on the meter.
Repeat the same procedure for the other channel.
Note: During this alignment no load should be connected to the speaker terminals.
3. Idle-current adjustment
Connect a VTVM between pin terminals J753 and J754. Next, rotate the trimming resistor R763 fully counterclockwise, then rotate it clockwise again until the VTVM reads 5mV DC.
Repeat the same procedure for the other channel.
4. Check DC off-set voltage aligned in the procedure 2 and if any DC output is observed on the DC voltmeter, adjust the R762 again for "zero" output.
5. Phono amplifier adjustment
Connect a oscilloscope to the TAPE OUT jacks and an audio signal generator to the PHONO jacks. Place the selector switch in the PHONO position. Increase 1KHz audio signal gradually until a slight clipping on top of the sine-wave is observed on the oscilloscope. Adjust the trimming resistor R708 for equal clipping level.
For the other channel adjust R709.
6. Main Amplifier ASO adjustment
For this alignment two DC oscilloscopes are necessary.
 - 6.1 First, make calibration on each oscilloscope gain for;
 - Vertical Sensitivity 0.2 V/cm
 - Horizontal Sensitivity 10 V/cm
 - 6.2 Connect pin J753 to the scope vertical input terminal. Connect pin J756 to the scope horizontal input terminal. Adjust the horizontal and vertical position knobs so that a "spot" on the scope is placed on the lower right corner.
 - 6.3 Connect pin J760 to the scope vertical input terminal. Connect pin J761 to the scope ground terminal. Connect pin J756 to the scope horizontal input terminal. Adjust the horizontal and vertical position knobs so that a "spot" on the scope is placed on the lower left corner.
 - 6.4 Remove two jumper plugs connected between the PRE OUT and MAIN IN jacks on the ear panel. Connect a low-loss oil paper capacitor of 6 μ F (or equivalent) to the speaker terminals being adjusted.
 - 6.5 Connect an audio signal generator to the MAIN IN jack. Increase the audio signal (1KHz) input level until the Lissajou Figures as shown below are obtained on the scopes. Adjust the trimming resistors R782 and R783 for the height of 2.5cm.
 - 6.6 Change the audio input frequency from 1KHz to 20Hz and check whether the speaker

protection relay has been operated or not. (When the relay has been operated, no signal is provided to the speaker terminals.) If there is no signal at the speaker terminals, turn off the system power of the amplifier for about one minutes, then again turn on the power and adjust the R782 and R783 for a slight increased height of A and B.

6.7 For the another Main Amplifier, repeat the procedures 6.2 to 6.6.

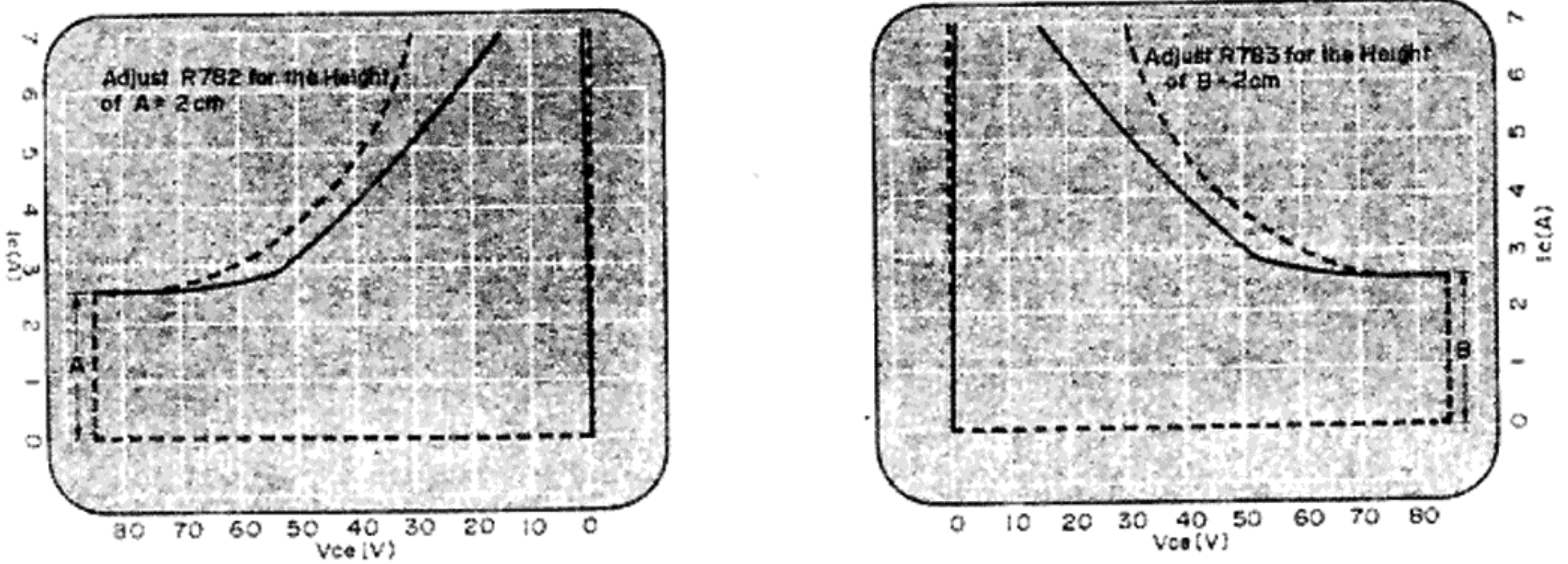

Figure 3. Lissajou Figure on Oscilloscope

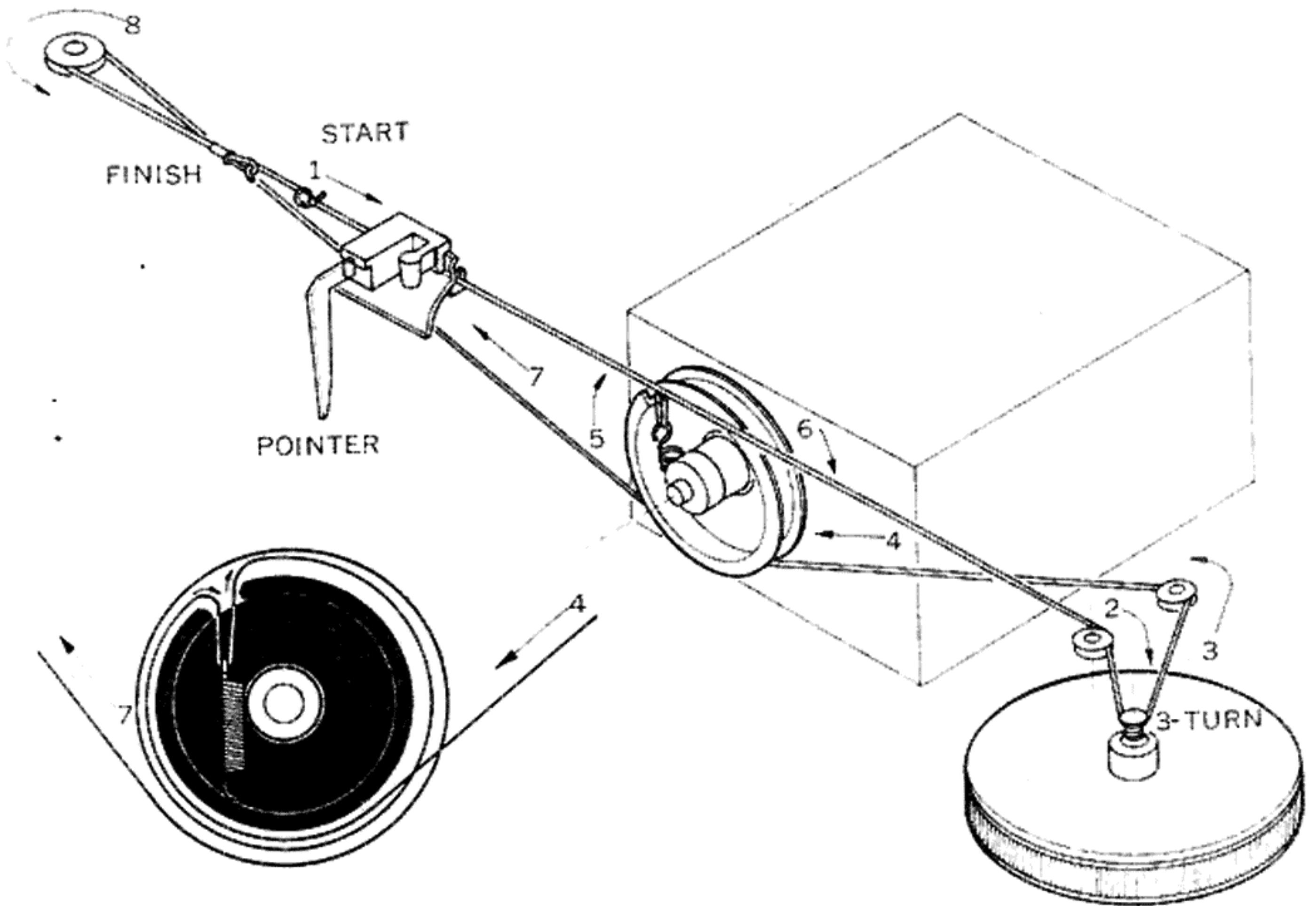

Figure 4. Dial Stringing

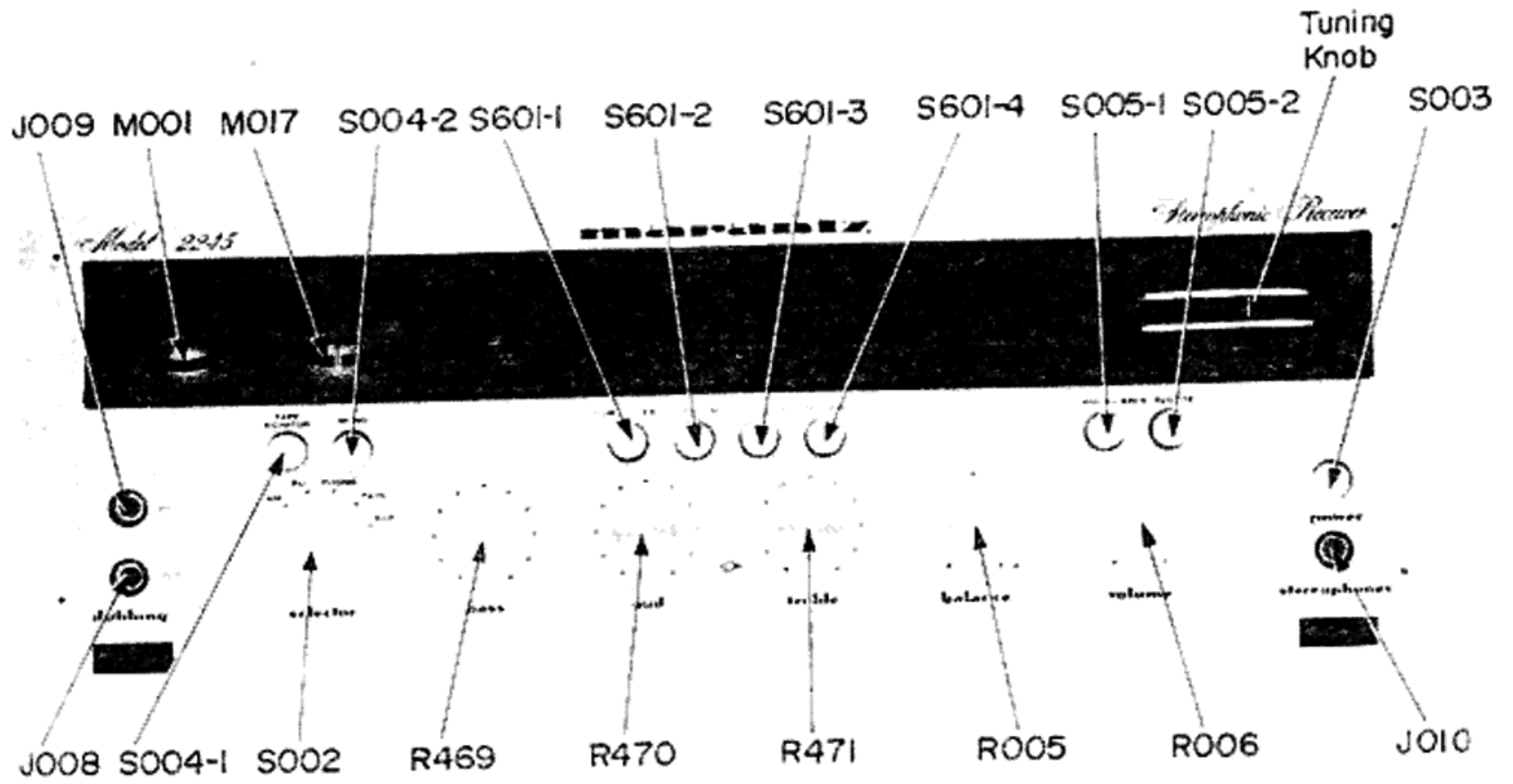

Figure 5. Front Panel Adjustment and Component Locations

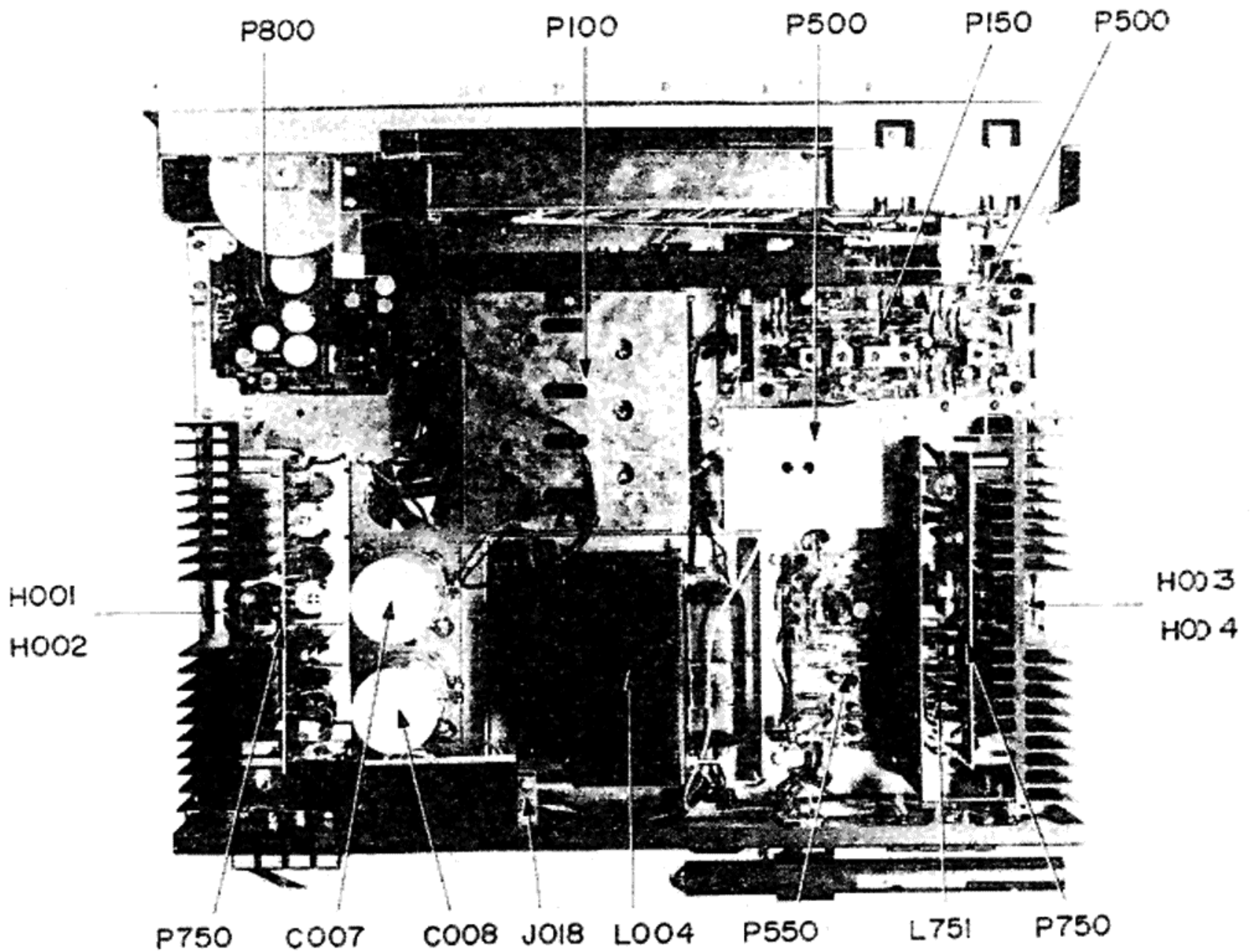

Figure 6. Main Chassis Component Locations (Top View)

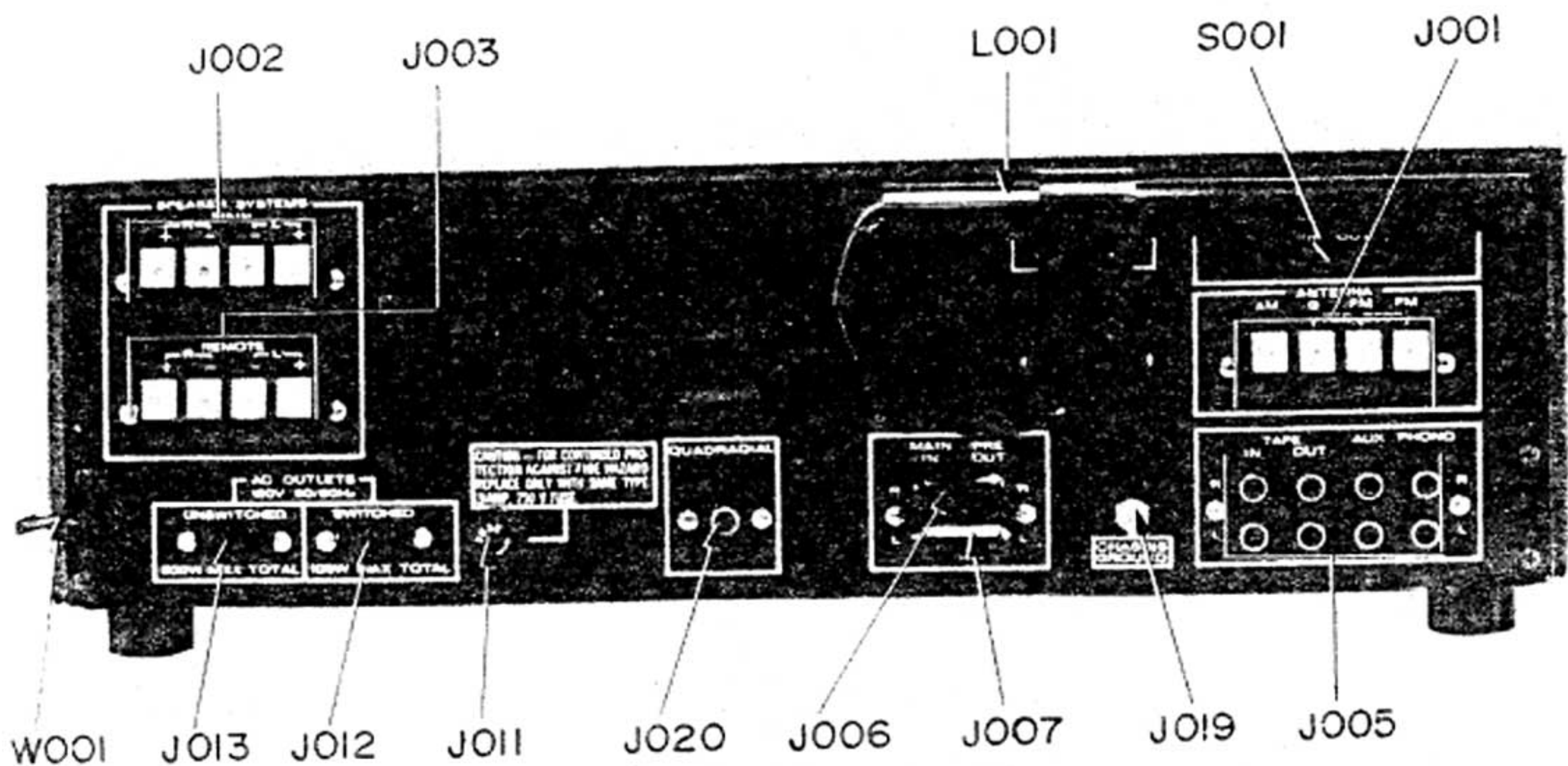

Figure 7. Rear Panel Adjustment and Component Locations

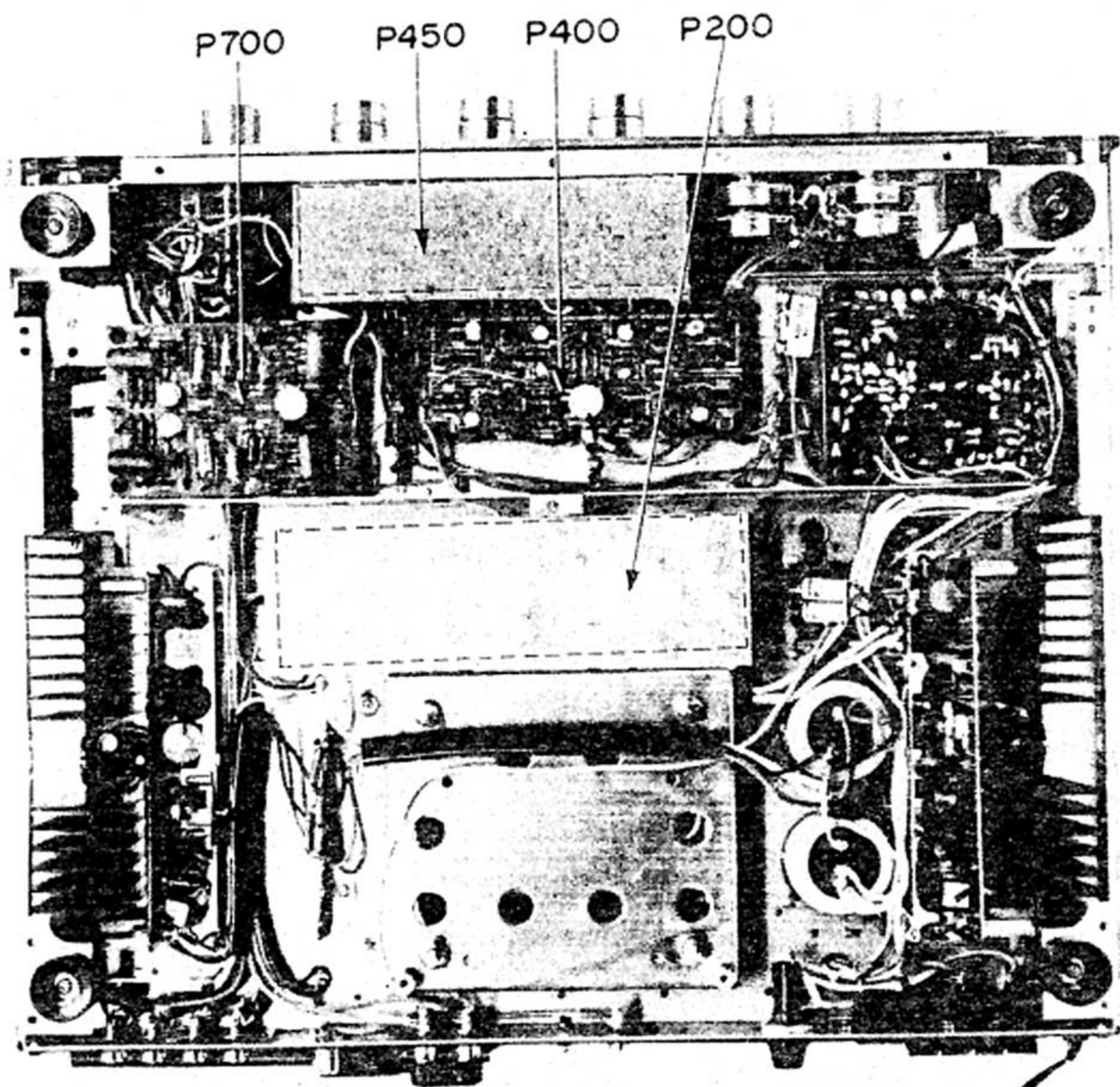

Figure 8. Main Chassis Component Locations (Bottom View)

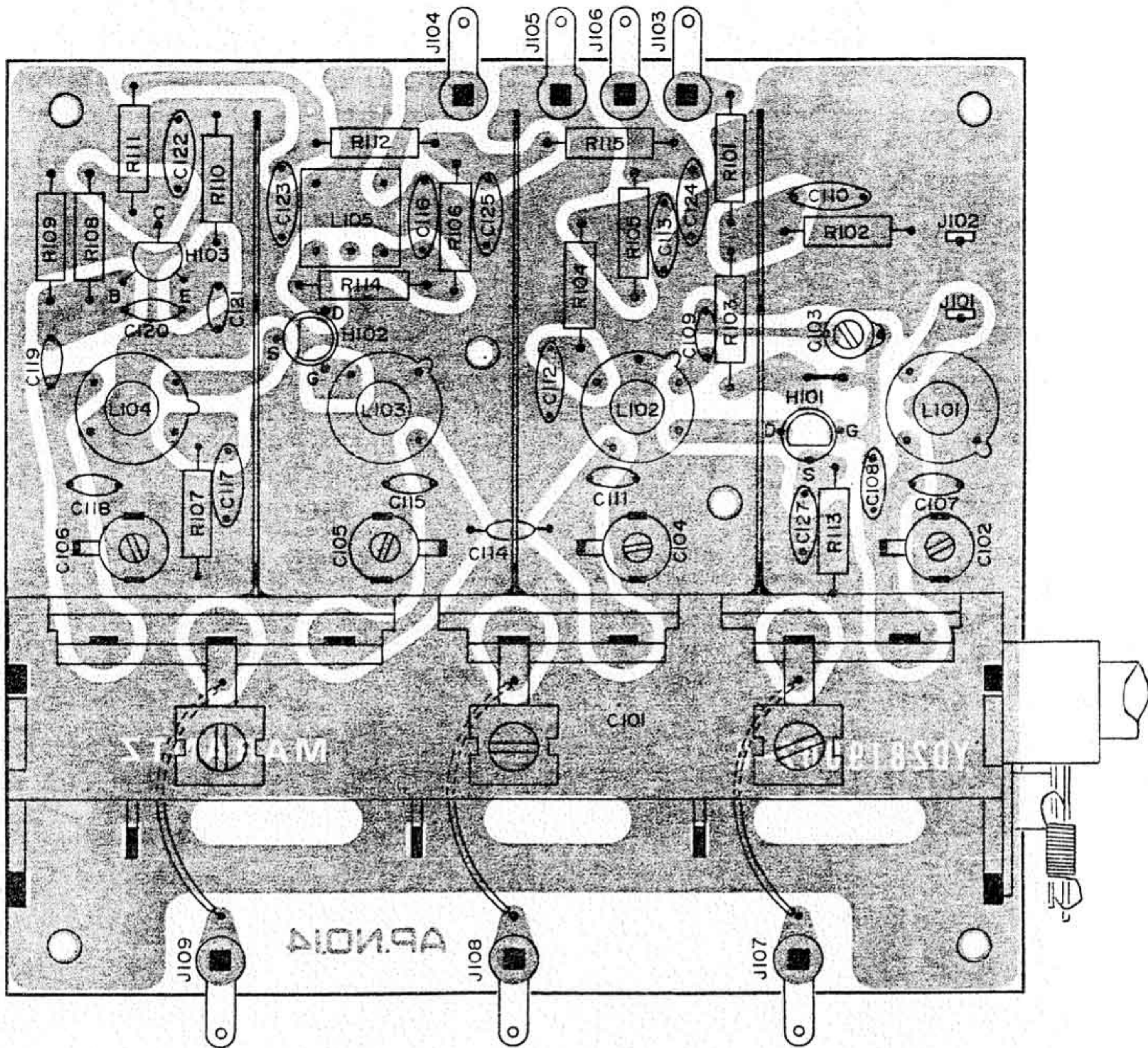

Figure 9. FM Front End Assembly P100 Component Locations

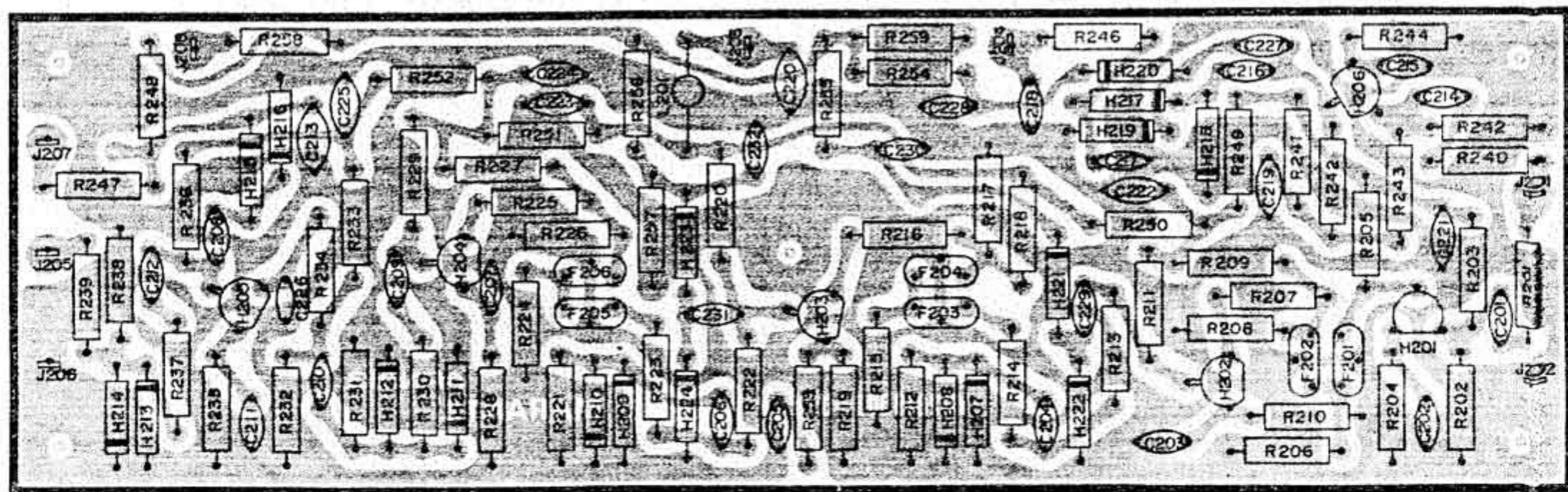

Figure 10. FM IF Amplifier Assembly P200 Component Locations

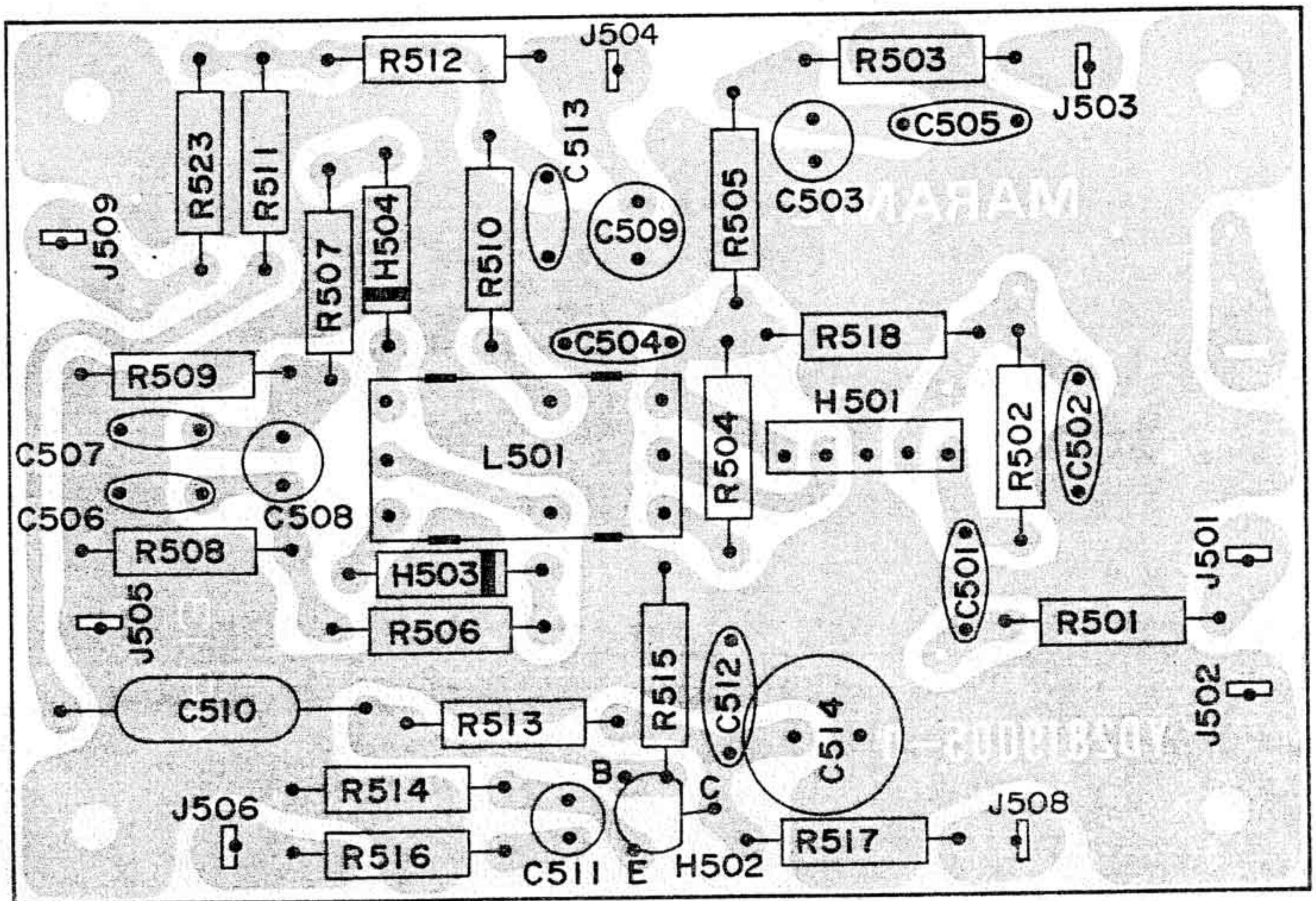

Figure 11. FM Detector Assembly P500 Component Locations

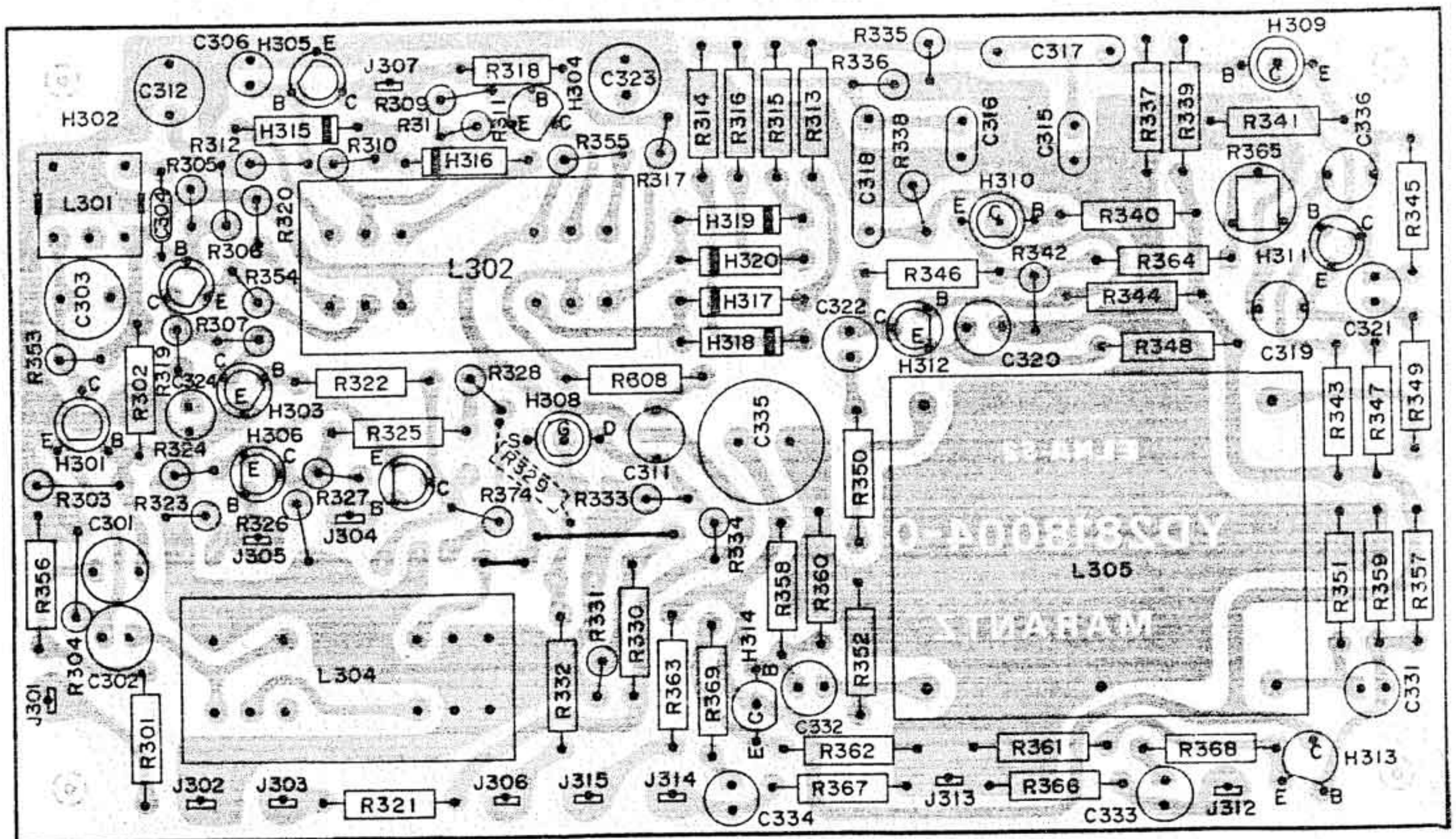

Figure 12. MPX Stereo Decoding Amplifier Assembly P300 Component Locations

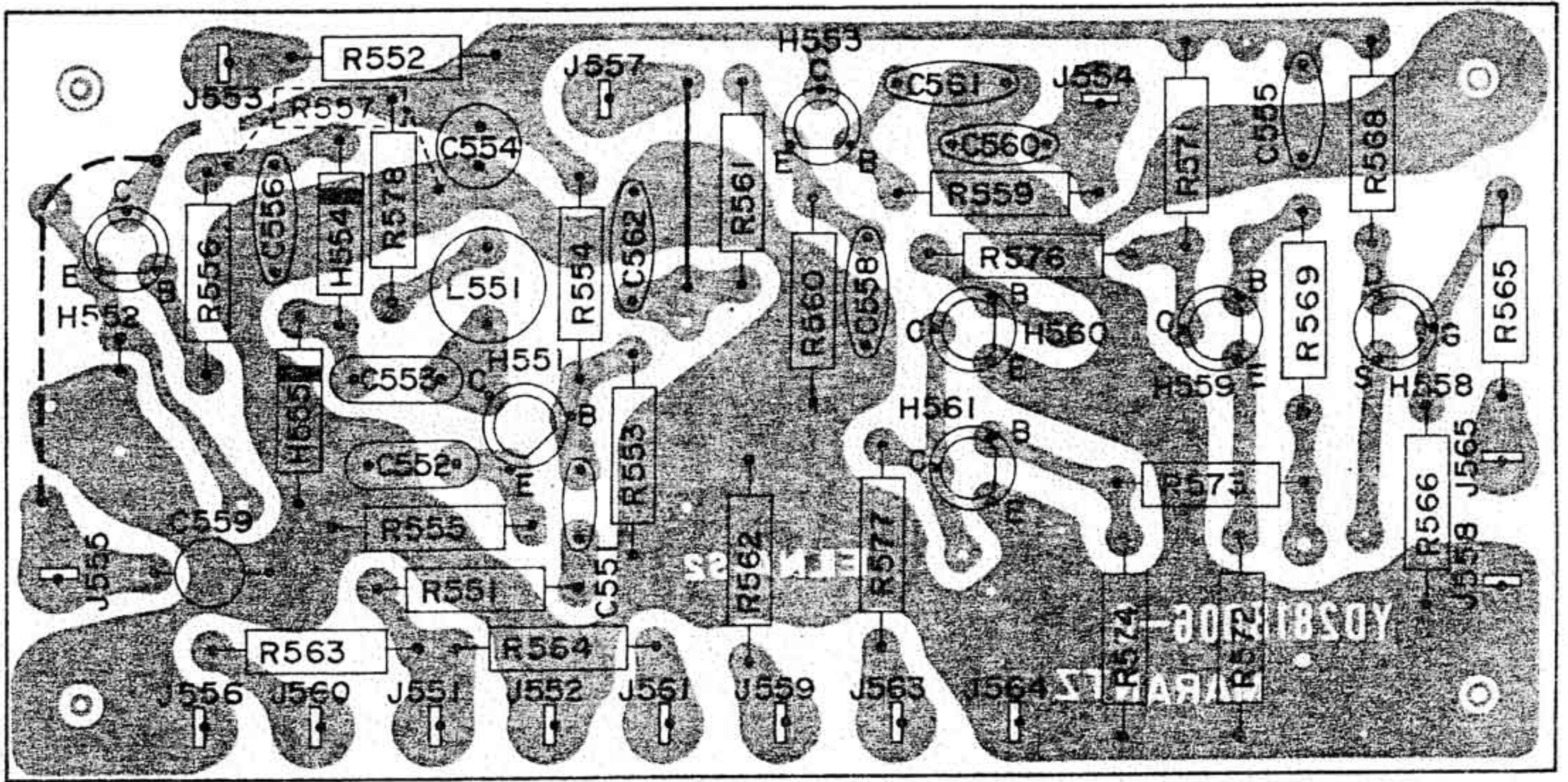

Figure 13. Muting Control Amplifier Assembly P550 Component Locations

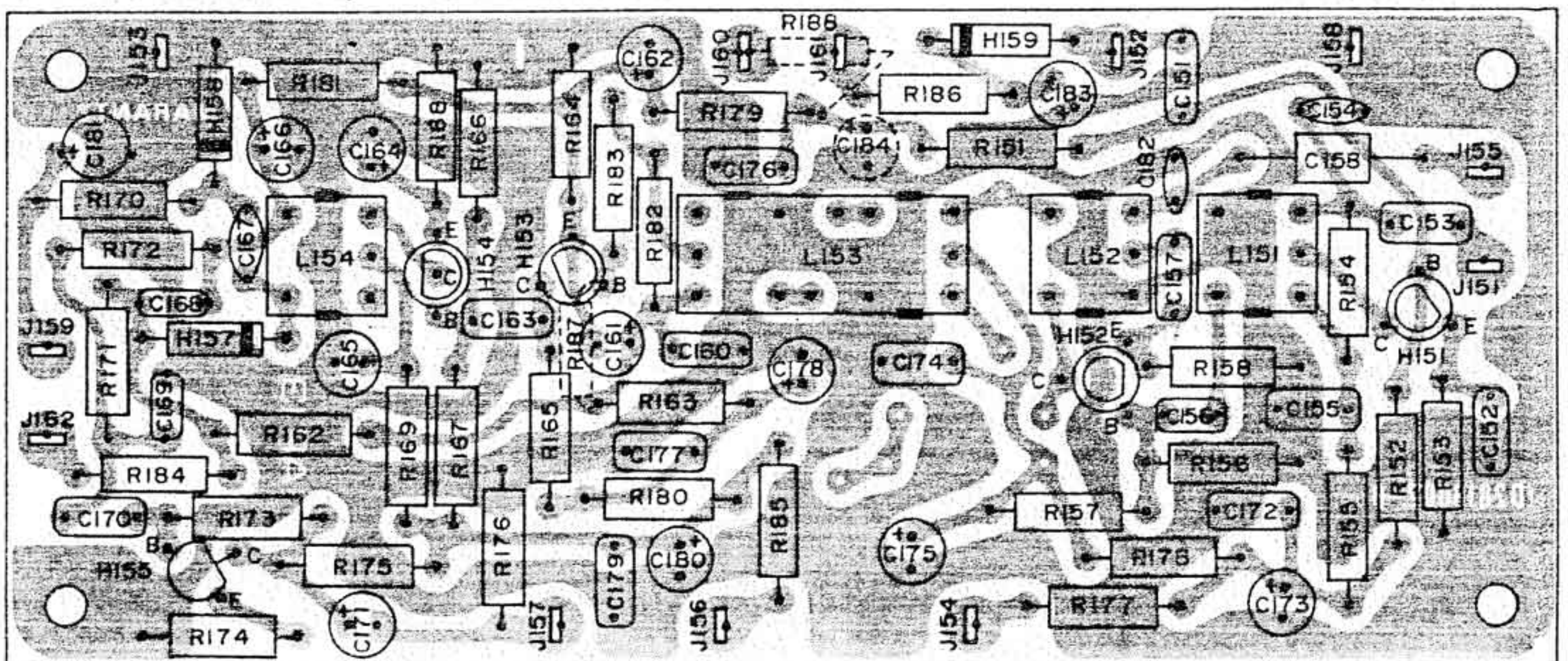

Figure 14. AM Tuner Unit Assembly P150 Component Locations

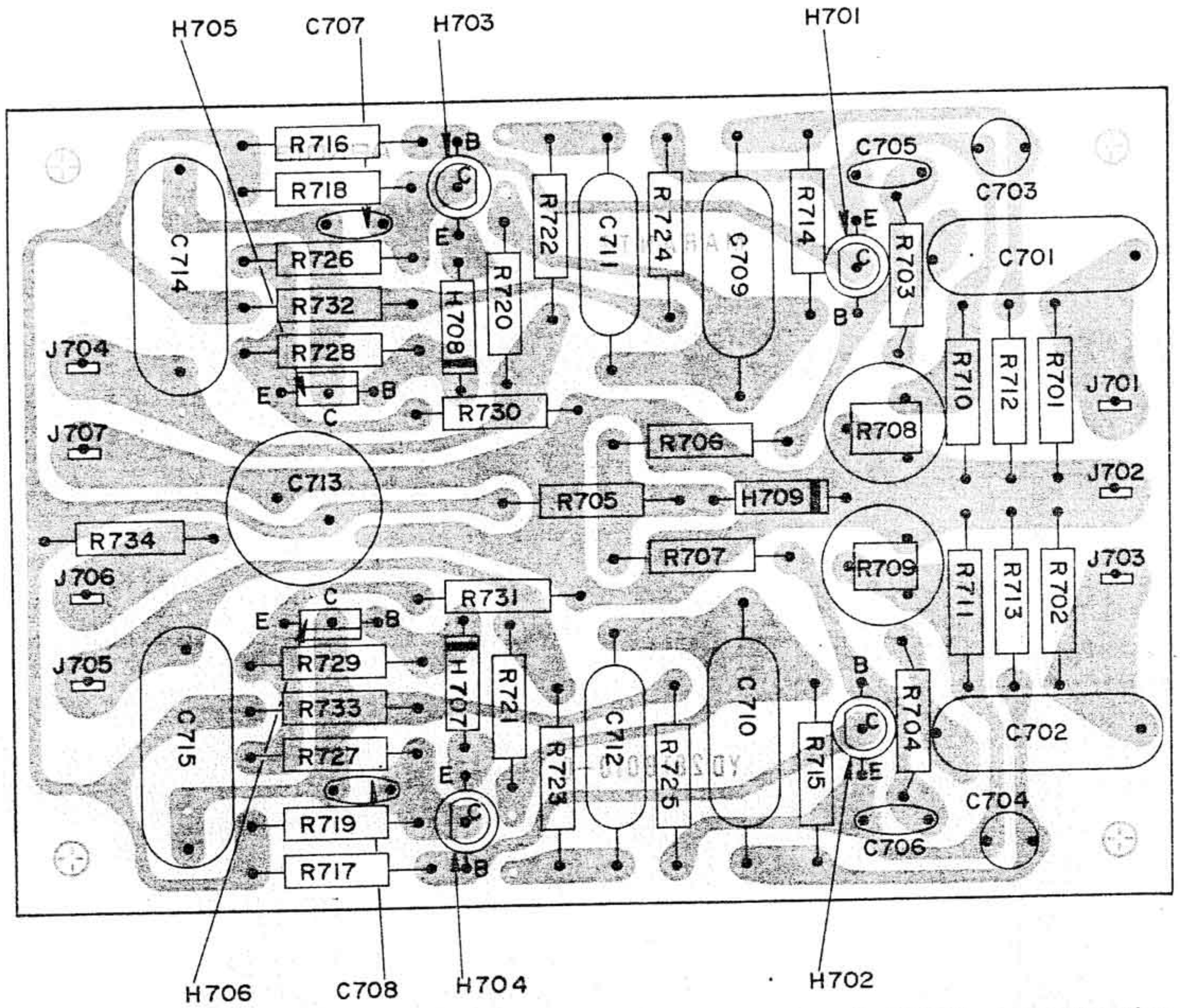

Figure 15. Phono Amplifier Assembly P700 Component Locations

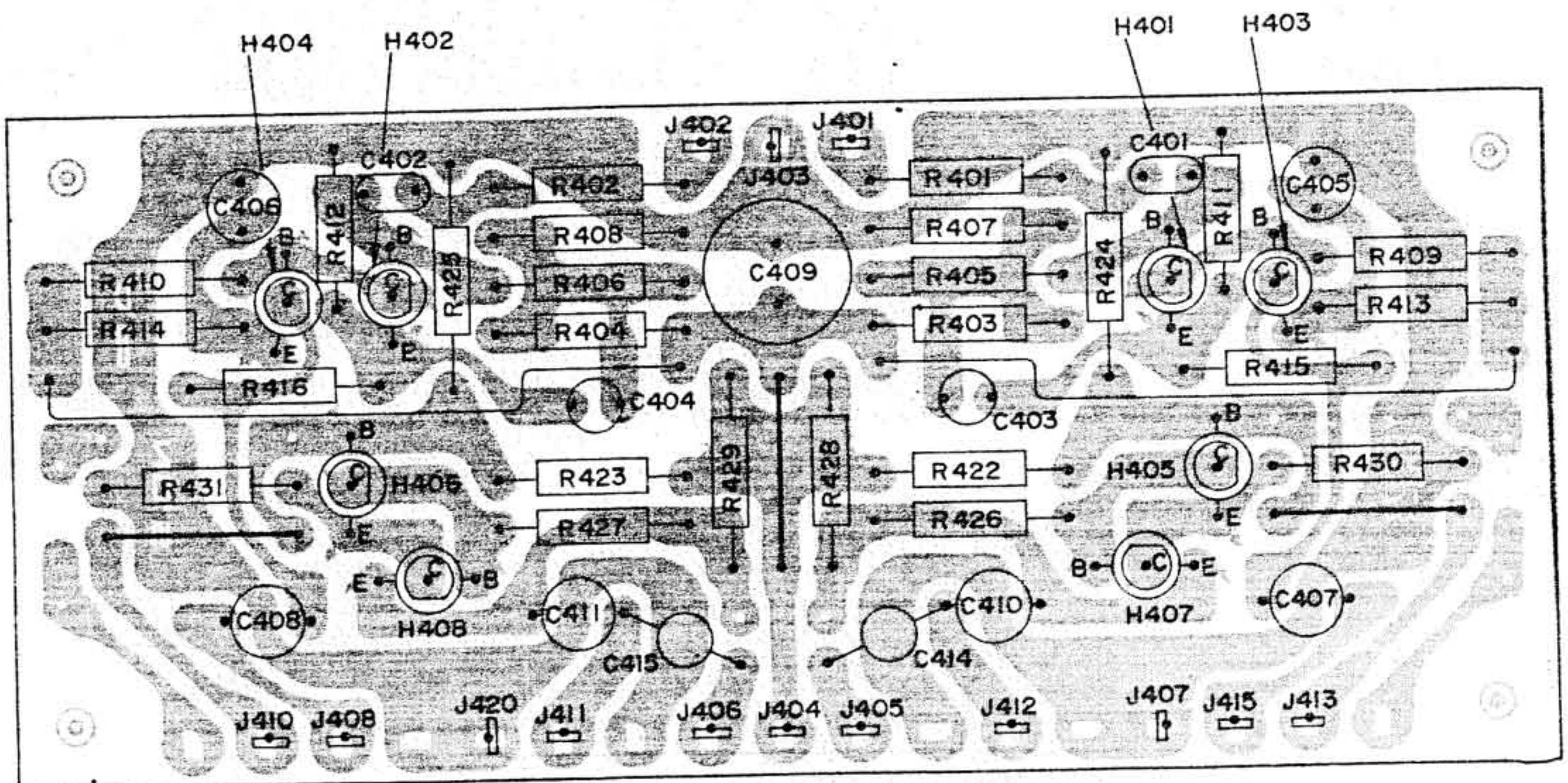

Figure 16. Tone Amplifier Assembly P400 Component Locations

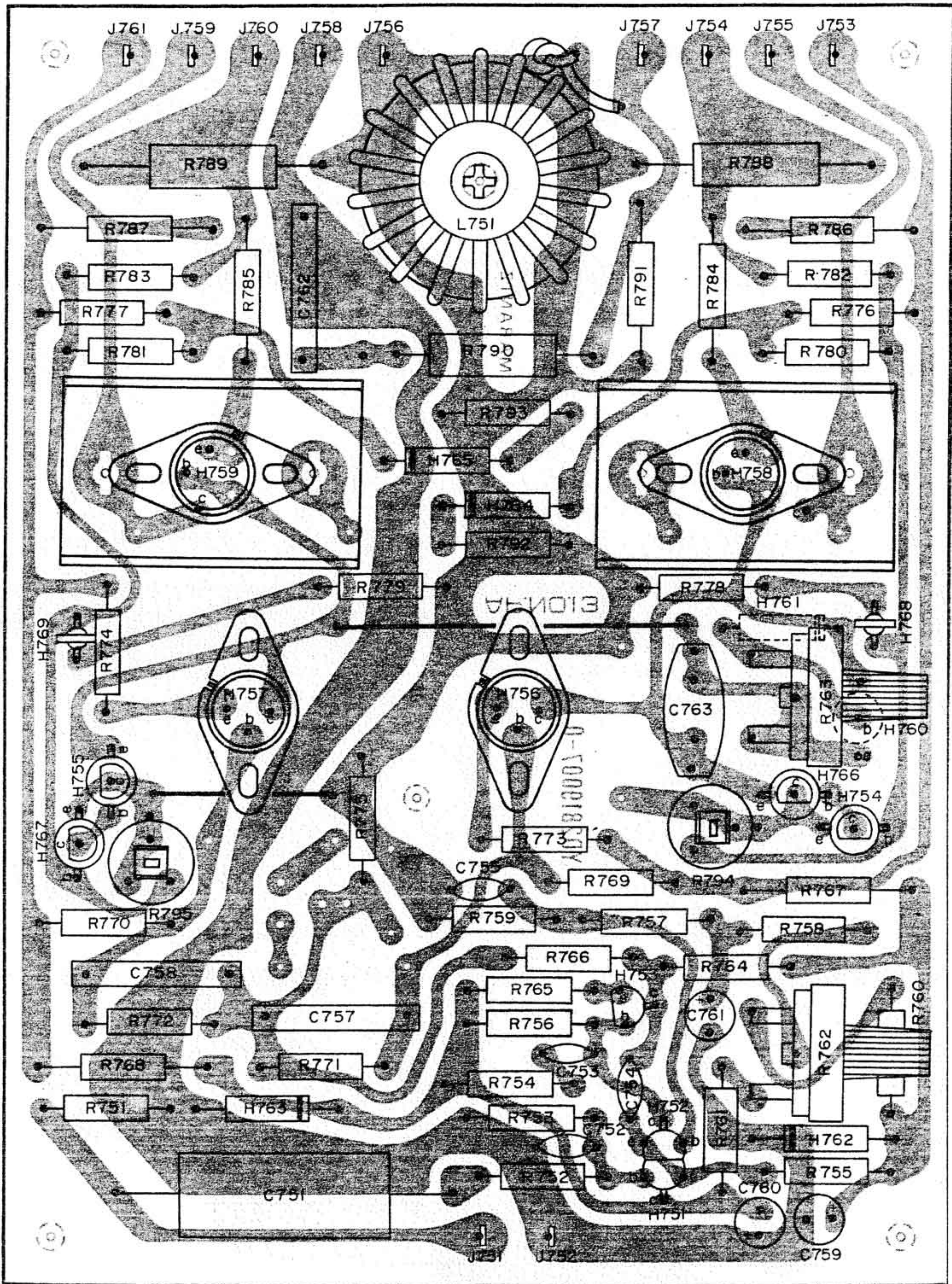

Figure 17. Power Amplifier Assembly P750 Component Locations

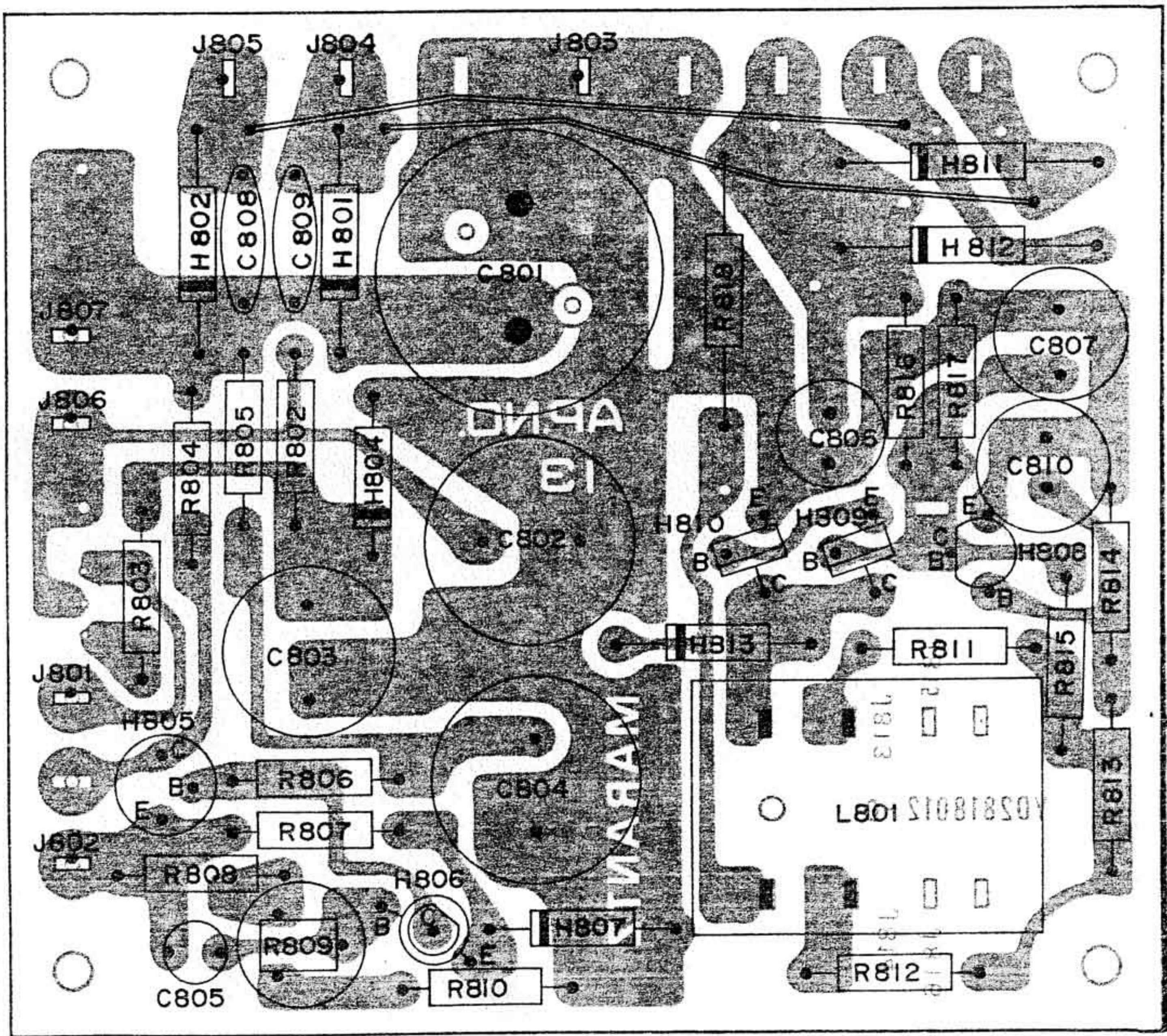

Figure 18. Regulated Power Supply and Protection Relay Circuit Assembly P800 Component Locations

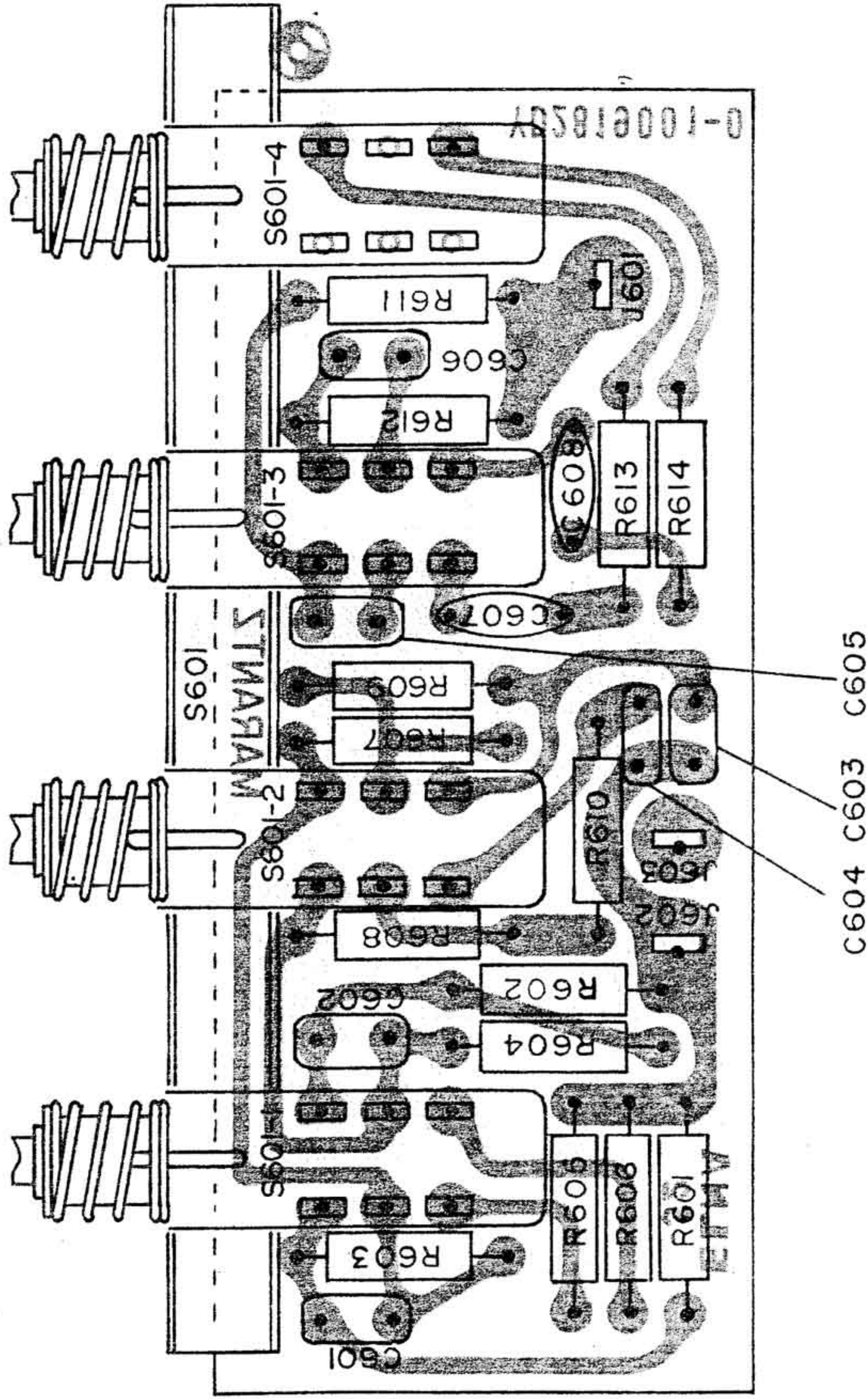

Figure 19. Loudness, High and Low Filter and Muting Switch Unit Assembly P600 Component Locations

REF. DESIG.	MARANTZ PART NO.	DESCRIPTION
		MECHANICAL PARTS
A	281940140	Frame Assembly
0102	281906301	Escutcheon
0202	281840101	Frame
0204	281815801	Window
0215	273125901	Bush
0219	281905302	Cover x 3
0226	281825905	Bush x 9
B	281815440	Knob Assembly (Tone) x 3
0111	281815404	Knob
0112	71400149Q	Spring
C	281815441	Knob Assembly (Double) (Tone) x 3
0114	28185405	Knob
0115	71400159Q	Spring
D	281816040	Bracket Assembly (Front)
0206	281811801	Spacer
0311	281816001	Bracket
E	281816041	Bracket Assembly (Back)
0313	281916002	Bracket
0902	55060305F	T. R. Rivet x 12
0905	55060365F	T. R. Rivet x 4
J001-J003	YT0304003	Push Type Terminal x 3
J004	YT0204003	4P Terminal
J005	YT0208002	8P Terminal
J012	YJ0400018	AC Outlet Jack x 2
J020	YT0201006	1P Quad Radial Terminal
0104	281815401	Knob (Push) x 8
0106	281815402	Knob (Power) x 8
0108	281815403	Knob x 3
0117	281825701	Lid
0118	281825702	Lid
0121	257706302	Escutcheon (Fly Wheel)
0122	257706303	Escutcheon (Fly Wheel)
0123	257727301	Fly Wheel
0126	281926501	Indicator
0208	281810701	Sheet
0210	281810301	Pointer
0211	281810302	Pointer
0212	281805301	Cover (Pointer) x 4
0217	275905701	Leg
0221	281930202	Dial
0302	281810550	Chassis K
0308	273010401	Retainer x 2
0315	281816003	Bracket
0316	281816004	Bracket
0317	281816051	Bracket K
0321	281805501	Collar x 5
0326	281827401	Reflector
0327	281827402	Reflector
0329	281827101	Holder

REF. DESIG.	MARANTZ PART NO.	DESCRIPTION
0330	281927106	Holder
0331	281827103	Holder
0332	281927107	Holder
0401	281805101	Guide
0403	28186005	Bracket
0406	281810650	Bearing K
0410	257811202	Shaft (Fly Wheel)
0412	281826250	Pulley K
0417	281926251	Pulley K
0422	257912001	Insulator
0423	281812001	Insulator
0425	141511801	Spacer
0426	257710602	Bearing
0501	257816052	Bracket K
0506	145525901	Bush x 2
0508	53228059E	Nut (Muting Vol.)
0510	281816006	Bracket
0516	281826701	Heat Sink x 2
0518	281810104	Support x 8
0520	281816007	Bracket x 4
0522	257711802	Spacer x 4
0524	257711806	Spacer x 4
0524	257711806	Spacer
0526	281926702	Heat Sink x 4
0530	281926705	Heat Sink x 2
0532	257700501	Clamper x 2
0533	59110339H	Washer x 2
0535	281910101	Support x 2
0601	281800450	Table K
0605	273010950	Shield K (Front End)
0609	273010902	Shield (")
0611	273010903	Shield (") x 3
0615	281916008	Bracket x 2
0617	281910901	Shield
0618	281912002	Insulator x 2
0619	281910902	Shield
0620	282210903	Shield
0623	281810107	Support x 4
0624	281816009	Bracket x 2
0626	281810906	Shield
0627	281810907	Shield
0629	281926901	Protector
0630	282126902	Protector
0631	282112001	Insulator
0633	281912001	Insulator x 2
0701	281915901	Brum
0703	71101569M	Spring
0707	281910701	Sheet
0711	120225801	Hook
0716	273025901	Bush x 3
0718	138200503	Clamper x 15
0722	72081602A	String x 120
0725	257711803	Spacer x 4

REF. DESIG.	MARANTZ PART NO.	DESCRIPTION
0729	282111801	Spacer
0731	281900501	Clamper
0732	282100501	Clamper x 2
0734	281927103	Holder (AM Ant.)
0735	281905102	Guide (V.C Stopper)
0802	51570305B	P. H. Tapt Screw x 8
0804	51570306B	P. H. Tapt Screw x 7
0806	51570312B	P. H. Tapt Screw x 5
0807	54050300R	T. L. Washer x 2
0808	51100306E	B. H. M. Screw x 2
0809	51040306A	F. H. M. Screw x 2
0810	51640412D	Set Screw C P
0811	54040402A	Spring Washer
0811	53110403E	Hexagon Nut
0814	51570408B	P. H. Tapt Screw x 2
0815	51570306B	P. H. Tapt Screw x 4
0816	51570306B	P. H. Tapt Screw x 6
0818	51042606S	F. H. M. Screw x 6
0820	51570306B	P. H. Tapt Screw x 3
0821	51570306B	P. H. Tapt Screw x 6
0822	51570306B	P. H. Tapt Screw x 2
0823	51570306B	P. H. Tapt Screw x 3
0824	51570306B	P. H. Tapt Screw x 2
0831	53110603A	Hexagon Nut
0832	54040602A	Spring Washer
0833	54020601E	Flat Washer P
0835	53110303E	Hexagon Nut
0903	53110303E	Hexagon Nut x 12
0906	54050300R	T. L. Washer OR x 4
0909	51100306S	B. H. Tapt Screw x 6
0910	51100306S	B. H. Tapt Screw x 3
0911	51100306S	B. H. Tapt Screw x 2
0912	51100306S	B. H. Tapt Screw x 2
0913	51100306S	B. H. Tapt Screw x 2
0914	51570312B	P. H. Tapt Screw x 4
0917	51100304S	B. H. M. Screw x 2
0919	51100308S	B. H. M. Screw x 2
0920	54050300R	T. L. Washer OR x 2
0921	53110303E	Hexagon Nut x 2
0923	54050400R	T. L. Washer OR
0926	51122608E	T. H. M. Screw x 4
0928	51100406S	B. H. M. Screw x 10
0930	51100406S	B. H. M. Screw x 4
0931	54020401S	Flat Washer P x 4
0933	51570410B	P. H. Tapt Screw x 4
0934	54020401E	Flat Washer P x 4
0935	54040402N	Spring Washer x 4
1002	51570306B	P. H. Tapt Screw x 12
1003	51570306B	P. H. Tapt Screw x 8
1005	51100314E	P. H. M. Screw x 8
1013	51100306S	B. H. M. Screw x 10
1015	51102608E	B. H. M. Screw x 2

REF. DESIG.	MARANTZ PART NO.	DESCRIPTION
1017	51060425E	P. H. M. Screw x 2
1018	54050400R	T. L. Washer OR x 2
1019	54040402E	Spring Washer x 2
1020	53110403E	Hexagon Nut x 2
1022	51100206E	B. H. M. Screw x 8
1023	54020201E	Flat Washer P x 8
1026	51570408B	P. H. Tapt Screw x 4
1027	53110403A	Hexagon Nut x 4
1028	54020401A	Flat Washer P x 4
1030	54040502A	Spring Washer x 4
1031	51060512A	P. H. M. Screw x 4
1032	53110501A	Hexagon Nut x 4
1033	54020501A	Flat Washer P x 8
1034	62031650W	Lug x 5
1035	54050300R	T. L. Washer OR x 15
1102	51100306S	B. H. M. Screw x 4
1103	51100306S	B. H. M. Screw x 4
1104	51100306S	B. H. M. Screw x 4
1105	51100306S	B. H. M. Screw x 4
1106	51100306S	B. H. M. Screw x 5
1107	51100306S	B. H. M. Screw x 4
1108	51100306S	B. H. M. Screw x 5
1109	51100306S	B. H. M. Screw x 4
1110	51100306S	B. H. M. Screw x 4
1113	51570306B	B. H. Tapt Screw x 3
1114	62031650W	Lug x 5
1115	62031650W	Lug
1121	51570306B	P. H. Tapt Screw x 4
1122	51570306B	P. H. Tapt Screw x 4
1123	51570306B	P. H. Tapt Screw x 3
1124	51570306B	P. H. Tapt Screw x 8
1125	51570306B	P. H. Tapt Screw x 2
1126	51570306B	P. H. Tapt Screw x 4
1127	51570306B	P. H. Tapt Screw x 2
1128	51570306B	P. H. Tapt Screw x 4
1129	51570306B	P. H. Tapt Screw x 10
1130	51570306B	P. H. Tapt Screw x 15
1202	51650304D	Set Screw H. P. x 2
1203	53110403E	Hexagon Nut x 2
1212	56382540G	Eyelet
1216	51100310S	B. H. M. Screw x 2
1217	53110303E	Hexagon Nut x 2
1218	54050300R	T. L. Washer OR x 2
1221	53112603E	Hexagon Nut
1222	54052600R	T. L. Washer OR
1223	59030810P	Fiber Washer
1224	54060300R	T. L. Washer x 5
1225	51060305E	P. H. M. Screw x 3
1227	51570306B	P. H. Tapt Screw x 2
1229	54040302N	Spring Washer x 4

REF. DESIG.	MARANTZ PART NO.	DESCRIPTION
P100	YD2819002 (ZZ2819002)	ELECTRICAL PARTS P. C. Board P. C. Board Assembly
RESISTORS		
R101	RT1056314	Carbon, 56K Ω , $\pm 10\%$, 1/4W
R102	RT1010514	Carbon, 1M Ω , $\pm 10\%$, 1/4W
R103	RT1010414	Carbon, 100K Ω , $\pm 10\%$, 1/4W
R104-R105	RT1022114	Carbon, 220 Ω , $\pm 10\%$, 1/4W
R106	RT1010214	Carbon, 1K Ω , $\pm 10\%$, 1/4W
R107	RT1047214	Carbon, 4.7K Ω , $\pm 10\%$, 1/4W
R108-R109	RT1022314	Carbon, 22K Ω , $\pm 10\%$, 1/4W
R110	RT1012214	Carbon, 1.2K Ω , $\pm 10\%$, 1/4W
R111-R113	RT1010114	Carbon, 100 Ω , $\pm 10\%$, 1/4W
R114	RT1022314	Carbon, 22K Ω , $\pm 10\%$, 1/4W
R115	RT1010114	Carbon, 100 Ω , $\pm 10\%$, 1/4W
CAPACITORS		
C101	CA4330001	Variable, FM4 AM3 Gang
C102	CT1100001	Trimmer, 1.5pF~10pF NPO
C103	CT1100002	Trimmer, 1.5pF~10pF NPO
C104	CT1100001	Trimmer, 1.5pF~10pF NPO
C105	CT1100001	Trimmer, 1.5pF~10pF NPO
C106	CT1100001	Trimmer, 1.5pF~10pF NPO
C107	DD1615001	Ceramic, 15pF, $\pm 10\%$, SL
C108	DK1710201	Ceramic, 1000pF, $\pm 20\%$, YY
C109	DD1105001	Ceramic, 5pF, $\pm 0.5pF$, SL
C110	DK1710201	Ceramic, 1000pF $\pm 20\%$, YY
C111	DD1615001	Ceramic, 15pF, $\pm 10\%$, SL
C112	DK1710201	Ceramic, 1000pF, $\pm 20\%$, YY
C113	DK1710301	Ceramic, 0.01 μF , $\pm 20\%$, YY
C114	DD1001001	Ceramic, 1.0pF, $\pm 0.25pF$, SL
C115	DD1615001	Ceramic, 15pF, $\pm 10\%$, SL
C116-C117	DK1710301	Ceramic, 0.01 μF , $\pm 20\%$, YY
C118	DD1620003	Ceramic, 20pF, $\pm 10\%$, SH
C119	DD1210006	Ceramic, 10pF, $\pm 1pF$, CH
C120-C121	DD1615003	Ceramic, 15pF, $\pm 10\%$, CH
C122-C125	DK1710301	Ceramic, 0.01 μF , $\pm 20\%$, YY
C127	DK1710301	Ceramic, 0.01 μF , $\pm 20\%$, YY
TRANSFORMERS		
L101	LA1202603	Ant. Coil x 3
L102	LA1202604	RF Coil
L103	LA1202605	RF Coil
L104	LO1202603	OSC Coil
L105	LI1001601	IFT
SEMICONDUCTORS		
H101	HF200191A	Transistor, 2SK19Y x 3
H102	HF200191B	Transistor, 2SK19G
H103	HT305351B	Transistor, 2SC535B
MISCELLANEOUS		
J101-J102	YP1000094	

REF. DESIG.	MARANTZ PART NO.	DESCRIPTION
J103-J109	57271240W	Lug Eyelet
P150	YD2818002 (ZZ2818002)	P. C. Board P. C. Board Assembly
RESISTORS		
R151	RT1033214	Carbon, 3.3K Ω , $\pm 10\%$, 1/4W
R152	RT1022414	Carbon, 220K Ω , $\pm 10\%$, 1/4W
R153	RT1039214	Carbon, 3.9K Ω , $\pm 10\%$, 1/4W
R154	RT1010414	Carbon, 100K Ω , $\pm 10\%$, 1/4W
R155	RT1022114	Carbon, 220 Ω , $\pm 10\%$, 1/4W
R156	RT1033214	Carbon, 3.3K Ω , $\pm 10\%$, 1/4W
R157	RT1015314	Carbon, 15K Ω , $\pm 10\%$, 1/4W
R158	RT1027214	Carbon, 2.7K Ω , $\pm 10\%$, 1/4W
R162	RT1018314	Carbon, 18K Ω , $\pm 10\%$, 1/4W
R163	RT1018414	Carbon, 180K Ω , $\pm 10\%$, 1/4W
R164	RT1010214	Carbon, 1K Ω , $\pm 10\%$, 1/4W
R165	RT1015214	Carbon, 1.5K Ω , $\pm 10\%$, 1/4W
R166	RT1018314	Carbon, 18K Ω , $\pm 10\%$, 1/4W
R167	RT1047314	Carbon, 47K Ω , $\pm 10\%$, 1/4W
R168	RT1010214	Carbon, 1K Ω , $\pm 10\%$, 1/4W
R169	RT1022114	Carbon, 220 Ω , $\pm 10\%$, 1/4W
R170	RT1015214	Carbon, 1.5K Ω , $\pm 10\%$, 1/4W
R171	RT1022214	Carbon, 2.2K Ω , $\pm 10\%$, 1/4W
R172	RT1047214	Carbon, 4.7K Ω , $\pm 10\%$, 1/4W
R173	RT1022414	Carbon, 220K Ω , $\pm 10\%$, 1/4W
R174	RT1022214	Carbon, 2.2K Ω , $\pm 10\%$, 1/4W
R175	RT1056214	Carbon, 5.6K Ω , $\pm 10\%$, 1/4W
R176	RT1010414	Carbon, 100K Ω , $\pm 10\%$, 1/4W
R177	RT1010214	Carbon, 1K Ω , $\pm 10\%$, 1/4W
R178	RT1010114	Carbon, 100 Ω , $\pm 10\%$, 1/4W
R179	RT1022214	Carbon, 2.2K Ω , $\pm 10\%$, 1/4W
R180	RT1010114	Carbon, 100 Ω , $\pm 10\%$, 1/4W
R181	RT1082114	Carbon, 820 Ω , $\pm 10\%$, 1/4W
R182	RT1056214	Carbon, 5.6K Ω , $\pm 10\%$, 1/4W
R183	RT1012314	Carbon, 12K Ω , $\pm 10\%$, 1/4W
R184	RT1082214	Carbon, 8.2K Ω , $\pm 10\%$, 1/4W
R185	RT1010114	Carbon, 100 Ω , $\pm 10\%$, 1/4W
R186	RT1056214	Carbon, 5.6K Ω , $\pm 10\%$, 1/4W
R187	RT1022214	Carbon, 2.2K Ω , $\pm 10\%$, 1/4W
R188	RT1010114	Carbon, 100 Ω , $\pm 10\%$, 1/4W
CAPACITORS		
C151	DF1740301	Mylar, 0.04 μF , $\pm 20\%$
C152	DF1710301	Mylar, 0.01 μF , $\pm 20\%$
C153	DF1740301	Mylar, 0.04 μF , $\pm 20\%$
C154	DD1105001	Ceramic, 5pF, $\pm 0.5pF$
C155	DF1740301	Mylar, 0.04 μF , $\pm 20\%$
C156	DF1747201	Mylar, 0.0047 μF , $\pm 20\%$
C157	DF1722301	Mylar, 0.022 μF , $\pm 20\%$
C158	DF6545101	Mylar, 450pF, $\pm 5\%$
C160	DF1740301	Mylar, 0.04 μF , $\pm 20\%$
C161-C162	EA1060169	Elect., 10 μF , 16V

REF. DESIG.	MARANTZ PART NO.	DESCRIPTION
C163	DF1740301	Mylar, 0.04 μ F, \pm 20%
C164-C166	EA1060169	Elect., 10 μ F, 16V
C167	DK1710201	Ceramic, 0.001 μ F, \pm 20%
C168	DF1747201	Mylar, 0.0047 μ F, \pm 20%
C169	DF1722201	Mylar, 0.0022 μ F, \pm 20%
C170	DF1668301	Mylar, 0.068 μ F, \pm 10%
C171	EA1060169	Elect., 10 μ F, 16V
C172	DF1740301	Mylar, 0.04 μ F, \pm 20%
C173	EA1060169	Elect., 10 μ F, 16V
C174	DF1740301	Mylar, 0.04 μ F, \pm 20%
C175	EA1060169	Elect., 10 μ F, 16V
C176-C177	DF1740301	Mylar, 0.04 μ F, \pm 20%
C178	EA1060169	Elect., 10pF, 16V
C179	DF1740301	Mylar, 0.04 μ F, \pm 20%
C180	EA1060169	Elect., 10 μ F, 16V
C181	EA1060169	Elect., 10 μ F, 16V
C182	DD1620001	Ceramic, 20pF, \pm 10%
C183	EA1070169	Elect., 10 μ F, 16V
TRANSFORMERS		
L151	LA1001017	RF Coil, 200 μ H
L152	LO1001042	OSC Coil, 120 μ H
L153	LI1028002	IFT
L154	LI1001048	IFT
L153	LI1028003	IFT
SEMICONDUCTORS		
H151-H152	HT309411B	Transistor, 2SC941 (O)
H153	HT3037210	Transistor, 2SC372
H154	HT3037210	Transistor, 2SC372
H155	HT306441C	Transistor, 2SC644 (T)
H157-H159	HD1000105	Diode, 1N60
MISCELLANEOUS		
J151-J162	YP1000094	Plug
P200	YD2819008 (ZZ2819008)	P. C. Board P. C. Board Assembly
RESISTORS		
R201	RT1015114	Carbon, 150 Ω , \pm 10%, 1/4W
R202	RT1015214	Carbon, 1.5K Ω , \pm 10%, 1/4W
R203	RT1033214	Carbon, 3.3K Ω , \pm 10%, 1/4W
R204-R205	RT1010214	Carbon, 1K Ω , \pm 10%, 1/4W
R206	RT1082114	Carbon, 820 Ω , \pm 10%, 1/4W
R207	RT1015114	Carbon, 150 Ω , \pm 10%, 1/4W
R208	RT1015214	Carbon, 1.5K Ω , \pm 10%, 1/4W
R209	RT1033214	Carbon, 3.3K Ω , \pm 10%, 1/4W
R210-R211	RT1010214	Carbon, 1K Ω , \pm 10%, 1/4W
R212	RT1010414	Carbon, 100K Ω , \pm 10%, 1/4W
R213-R214	RT1015114	Carbon, 150 Ω , \pm 10%, 1/4W
R215	RT1082114	Carbon, 820 Ω , \pm 10%, 1/4W

REF. DESIG.	MARANTZ PART NO.	DESCRIPTION
R216	RT1015114	Carbon, 150 Ω , \pm 10%, 1/4W
R217	RT1015214	Carbon, 1.5K Ω , \pm 10%, 1/4W
R218	RT1033214	Carbon, 3.3K Ω , \pm 10%, 1/4W
R219-R220	RT1010214	Carbon, 1K Ω , \pm 10%, 1/4W
R221	RT1010414	Carbon, 100K Ω , \pm 10%, 1/4W
R222	RT1015114	Carbon, 150 Ω , \pm 10%, 1/4W
R223	RT1022114	Carbon, 220 Ω , \pm 10%, 1/4W
R224	RT1082114	Carbon, 820 Ω , \pm 10%, 1/4W
R225	RT1015114	Carbon, 150 Ω , \pm 10%, 1/4W
R226	RT1082214	Carbon, 8.2K Ω , \pm 10%, 1/4W
R227	RT1015314	Carbon, 15K Ω , \pm 10%, 1/4W
R228-R229	RT1010214	Carbon, 1K Ω , \pm 10%, 1/4W
R230	RT1027114	Carbon, 270 Ω , \pm 10%, 1/4W
R231	RT1010414	Carbon, 100K Ω , \pm 10%, 1/4W
R232	RT1082214	Carbon, 8.2K Ω , \pm 10%, 1/4W
R233	RT1015314	Carbon, 15K Ω , \pm 10%, 1/4W
R234	RT1015114	Carbon, 150 Ω , \pm 10%, 1/4W
R236	RT1010214	Carbon, 1K Ω , \pm 10%, 1/4W
R237	RT1015114	Carbon, 150 Ω , \pm 10%, 1/4W
R238	RT1010414	Carbon, 100K Ω , \pm 10%, 1/4W
R239	RT1015114	Carbon, 150 Ω , \pm 10%, 1/4W
R240	RT1047114	Carbon, 470 Ω , \pm 10%, 1/4W
R241	RT1010114	Carbon, 100 Ω , \pm 10%, 1/4W
R242	RT1047214	Carbon, 4.7K Ω , \pm 10%, 1/4W
R243	RT1012314	Carbon, 12K Ω , \pm 10%, 1/4W
R244	RT1010214	Carbon, 1K Ω , \pm 10%, 1/4W
R245	RT1022214	Carbon, 2.2K Ω , \pm 10%, 1/4W
R246	RT1033314	Carbon, 33K Ω , \pm 10%, 1/4W
R247	RT1056314	Carbon, 56K Ω , \pm 10%, 1/4W
R248	RT1015314	Carbon, 15K Ω , \pm 10%, 1/4W
R249-R252	RT1010114	Carbon, 100 Ω , \pm 10%, 1/4W
R253	RT1022014	Carbon, 22 Ω , \pm 10%, 1/4W
R254	RT1010314	Carbon, 10K Ω , \pm 10%, 1/4W
R255	RT1018314	Carbon, 18K Ω , \pm 10%, 1/4W
R256	RT1022314	Carbon, 22K Ω , \pm 10%, 1/4W
R257	RT1027314	Carbon, 27K Ω , \pm 10%, 1/4W
R258	RT1022314	Carbon, 22K Ω , \pm 10%, 1/4W
R259	RT1012314	Carbon, 12K Ω , \pm 10%, 1/4W
CAPACITORS		
C201	DK1710301	Ceramic, 0.01 μ F, \pm 20%
C202	DK1710301	Ceramic, 0.01 μ F, \pm 20%
C203	DK1710301	Ceramic, 0.01 μ F, \pm 20%
C204	DK1710301	Ceramic, 0.01 μ F, \pm 20%
C205	DK1710301	Ceramic, 0.01 μ F, \pm 20%
C206-C207	DK1710301	Ceramic, 0.01 μ F, \pm 20%
C208	DK1710201	Ceramic, 0.001 μ F, \pm 20%
C209-C212	DK1710301	Ceramic, 0.01 μ F, \pm 20%
C213	DK1810402	Ceramic, 0.1 μ F, +80%, -20%
C214-C217	DK1710301	Ceramic, 0.01 μ F, \pm 20%
C218	DK1810402	Ceramic, 0.1 μ F, +80%, -20%
C219-C225	DK1840302	Ceramic, 0.04 μ F, +80%, -20%

REF. DESIG.	MARANTZ PART NO.	DESCRIPTION
C226	DD1540001	Ceramic, 40pF, ±5%
C227	DD1620101	Ceramic, 200pF, ±10%
C228	DK1710301	Ceramic, 0.01μF, ±20%
C229	DD1620101	Ceramic, 200pF, ±10%
C230	DK1710301	Ceramic, 0.01μF, ±20%
C231	DD1620101	Ceramic, 200pF, ±10%
C232	DK1710301	Ceramic, 0.01μF, ±20%
SEMICONDUCTORS		
H201	HT308291C	Transistor, 2SC829C
H202	HT308291C	Transistor, 2SC829C
H203	HT308291C	Transistor, 2SC829C
H204	HT308291C	Transistor, 2SC829C
H205	HT308291C	Transistor, 2SC829C
H206	HT308291C	Transistor, 2SC829C
H207-H214	HD2001105	Diode, 1S1555
H215-H224	HD1000105	Diode, 1N60
MISCELLANEOUS		
L201	LC1682002	Choke Coil, 6.8μH±20% 100mA
F201-F206	FF1107003	Ceramic Filter, SFA 10.7MHz
J201-J208	YP1000094	Plug
P300	YD2818004 (ZZ2818004)	P. C. Board P. C. Board Assembly
RESISTORS		
R369	RT1047114	Carbon, 470Ω, ±10%, 1/4W
R301	RT1010214	Carbon, 1KΩ, ±10%, 1/4W
R302-R303	RN1047414	Carbon, 470KΩ, ±10%, 1/4W
R304	RT1015214	Carbon, 1.5KΩ, ±10%, 1/4W
R305	RT1027314	Carbon, 27KΩ, ±10%, 1/4W
R306	RT1012314	Carbon, 12KΩ, ±10%, 1/4W
R307	RT1012214	Carbon, 1.2KΩ, ±10%, 1/4W
R308	RT1015214	Carbon, 1.5KΩ, ±10%, 1/4W
R309	RT1022214	Carbon, 2.2KΩ, ±10%, 1/4W
R310	RT1027314	Carbon, 27KΩ, ±10%, 1/4W
R311	RT1039114	Carbon, 390Ω, ±10%, 1/4W
R312	RT1012214	Carbon, 1.2KΩ, ±10%, 1/4W
R313-R316	RT0510214	Carbon, 1KΩ, ±10%, 1/4W
R317	RT1010314	Carbon, 10KΩ, ±10%, 1/4W
R318	RT1015314	Carbon, 15KΩ, ±10%, 1/4W
R319	RT1015114	Carbon, 150Ω, ±10%, 1/4W
R320	RT1010414	Carbon, 100KΩ, ±10%, 1/4W
R321	RT1022114	Carbon, 220Ω, ±10%, 1/4W
R322-R323	RT1022414	Carbon, 220KΩ, ±10%, 1/4W
R324	RT1033014	Carbon, 33Ω, ±10%, 1/4W
R325	RT1012414	Carbon, 120KΩ, ±10%, 1/4W
R326	RT1015314	Carbon, 15KΩ, ±10%, 1/4W
R327	RT1056214	Carbon, 5.6KΩ, ±10%, 1/4W
R328	RT1033314	Carbon, 33KΩ, ±10%, 1/4W
R329	RT1022414	Carbon, 220KΩ, ±10%, 1/4W
R330	RT1068314	Carbon, 68KΩ, ±10%, 1/4W
R331	RT1056314	Carbon, 56KΩ, ±10%, 1/4W
R332	RT0518414	Carbon, 180KΩ, ±5%, 1/4W

REF. DESIG.	MARANTZ PART NO.	DESCRIPTION
R333	RT1010414	Carbon, 100KΩ, ±10%, 1/4W
R334	RT1012414	Carbon, 120KΩ, ±10%, 1/4W
R335-R336	RT0515314	Carbon, 15KΩ, ±5%, 1/4W
R337-R338	RT0510414	Carbon, 100KΩ, ±5%, 1/4W
R339-R340	RN0582414	Carbon, 820KΩ, ±5%, 1/4W
R341-R342	RT0512214	Carbon, 1.2KΩ, ±5%, 1/4W
R343-R344	RN0522314	Carbon, 22KΩ, ±5%, 1/4W
R345-R346	RT0568214	Carbon, 6.8KΩ, ±5%, 1/4W
R347-R348	RT0510214	Carbon, 1KΩ, ±5%, 1/4W
R349-R350	RT0512214	Carbon, 1.2KΩ, ±5%, 1/4W
R351-R352	RT0536214	Carbon, 3.6KΩ, ±5%, 1/4W
R353	RT1082314	Carbon, 82KΩ, ±10%, 1/4W
R354	RT1022214	Carbon, 2.2KΩ, ±10%, 1/4W
R355	RT1056314	Carbon, 56KΩ, ±10%, 1/4W
R356	RT1010414	Carbon, 100KΩ, ±10%, 1/4W
R357-R358	RN1047414	Carbon, 470KΩ, ±10%, 1/4W
R359-R360	RN1022414	Carbon, 220KΩ, ±10%, 1/4W
R361-R362	RT1047214	Carbon, 4.7KΩ, ±10%, 1/4W
R363	RT1018214	Carbon, 1.8KΩ, ±10%, 1/4W
R364	RT1056114	Carbon, 560Ω, ±10%, 1/4W
R365	RA0502013	Trimmer, 5KΩ B
R366-R367	RT1022414	Carbon, 220KΩ, ±10%, 1/4W
R368	RT1047114	Carbon, 470Ω, ±10%, 1/4W
R374	RT1068214	Carbon, 6.8KΩ, ±10%, 1/4W
CAPACITORS		
C302	EA1060169	Elect., 10μF, 15V
C303	DF5547203	Mylar, 4700pF, ±5%
C304	DF1647201	Mylar, 4700pF, ±10%
C306	EA1060169	Elect., 10μF, 15V
C311	EA1060169	Elect., 10μF, 15V
C312	EA2270169	Elect., 22μF, 15V
C315-C316	DF1522301	Mylar, 0.002μF, ±5%
C317-C318	DF1722401	Mylar, 0.22μF, ±20%
C319-C320	EA1060359	Elect., 10μF, 35V
C311-C322	EA1060169	Elect., 10μF, 15V
C323	EA1070109	Elect., 100μF, 10V
C324	EM1040201	Elect., 0.1μF, 20V
C331-C332	EA4750359	Elect., 4.7μF, 35V
C333-C334	EV1050251	Elect., 1μF, 25V
C335	EA2270259	Elect., 220μF, 25V
C336	EA3360109	Elect., 33μF, 10V
TRANSFORMERS		
L301	LS1001007	M.P.X Coil 19KHz Amp.
L302	LS1503002	M.P.X Coil 19KHz, 38KHz z Block
L304	LS1503001	19KHz, 67KHz Trap.
L305	LS3501002	M.P.X Coil L. P. Filter
SEMICONDUCTORS		
H301-H307	HT3037210	Transistor, 2SC372
H308	HF200301C	Transistor, 2SK30Y
H309	HT307322A	Transistor, 2SC732 B or Gr

REF. DESIG.	MARANTZ PART NO.	DESCRIPTION
H310	HT307322A	Transistor, 2SC732 Bu or Gr
H311-H312	HT104942A	Transistor, 2SA494 Gr or Y
H313-H314	HT306441C	Transistor, 2SC644T
H315-H320	HD1000105	Diode 1N60
		MISCELLANEOUS
J301-J303	YP1000094	Plug
J305-J307	YP1000095	Plug
J312-J315	YP1000094	Plug
P500	YD2819005 (ZZ2819005)	P. C. Board P. C. Board Assembly
		RESISTORS
R501	RT1015114	Carbon, 150Ω, ±10%, 1/4W
R502	RT1010214	Carbon, 1KΩ, ±10%, 1/4W
R503	RT1010114	Carbon, 100Ω, ±10%, 1/4W
R504	RT1022314	Carbon, 22KΩ, ±10%, 1/4W
R505	RT1022114	Carbon, 220Ω, ±10%, 1/4W
R506-R507	RT0582114	Carbon, 820Ω, ±5%, 1/4W
R508-R509	RT0568214	Carbon, 6.8KΩ, ±5%, 1/4W
R510	RT1010114	Carbon, 100Ω, ±10%, 1/4W
R511	RT1056214	Carbon, 5.6KΩ, ±10%, 1/4W
R512	RT1015314	Carbon, 15KΩ, ±10%, 1/4W
R513	RN1018414	Carbon, 180KΩ, ±10%, 1/4W
R514	RN1022214	Carbon, 2.2KΩ, ±10%, 1/4W
R515	RN1010414	Carbon, 100KΩ, ±10%, 1/4W
R516	RT1010114	Carbon, 100Ω, ±10%, 1/4W
R517	RT1010114	Carbon, 100Ω, ±10%, 1/4W
R518	RT1039214	Carbon, 3.9KΩ, ±10%, 1/4W
R523	RT1010414	Carbon, 100KΩ, ±10%, 1/4W
		CAPACITORS
C501-C502	DK1710301	Ceramic, 0.01μF, ±20%, YY
C503	EA1060169	Elect., 10μF, 16V
C504	DK1710301	Ceramic, 0.01μF, ±20%, YY
C505	DK1840302	Ceramic, 0.04μF, +100%, -0%
C506-C507	DD1620101	Elect., 200pF, ±10%, SL
C508	EA1060169	Elect., 10μF, 16V
C509	EA1070109	Elect., 10μF, 10V
C510	ED1050501	Elect., 1μF, 50V
C511	EA1060169	Elect., 10μF, 16V
C512	DK1840302	Ceramic, 0.04μF, +100%, -0%
C513	DD1620101	Ceramic, 200pF, ±10%
C514	EA1070169	Elect., 10μF, 16V
		SEMICONDUCTORS
H501	HC1000105	IC TA7060P
H502	HT306441B	Transistor, 2SC644S
H503-H504	HD1000105	Diode 1N60
		MISCELLANEOUS
J501-J509	YP1000094	Plug
L501	LI1018801	IFT FM Det.

REF. DESIG.	MARANTZ PART NO.	DESCRIPTION
P550	YD2818006 (ZZ2818006)	P. C. Board P. C. Board Assembly
		RESISTORS
R551	RT1056214	Carbon, 5.6KΩ, ±10%, 1/4W
R552	RT1010114	Carbon, 100Ω, ±10%, 1/4W
R553	RT1027314	Carbon, 27KΩ, ±10%, 1/4W
R554	RT1010414	Carbon, 100KΩ, ±10%, 1/4W
R555	RT1010214	Carbon, 1KΩ, ±10%, 1/4W
R556-R557	RT1033314	Carbon, 33KΩ, ±10%, 1/4W
R559	RT1033314	Carbon, 33KΩ, ±10%, 1/4W
R560	RT1033214	Carbon, 3.3KΩ, ±10%, 1/4W
R561	RT1056214	Carbon, 5.6KΩ, ±10%, 1/4W
R562	RT1022414	Carbon, 220KΩ, ±10%, 1/4W
R563-R564	RT1010114	Carbon, 100Ω, ±10%, 1/4W
R565	RT1010114	Carbon, 15KΩ, ±10%, 1/4W
R566	RT0533414	Carbon, 330KΩ, ±10%, 1/4W
R568	RT1022214	Carbon, 2.2KΩ, ±10%, 1/4W
R569	RT0510314	Carbon, 10KΩ, ±5%, 1/4W
R571	RT0527414	Carbon, 270KΩ, ±5%, 1/4W
R572	RT1010114	Carbon, 100Ω, ±10%, 1/4W
R573	RT0515314	Carbon, 15KΩ, ±5%, 1/4W
R574	RT0512314	Carbon, 12KΩ, ±5%, 1/4W
R576	RT0510314	Carbon, 10KΩ, ±5%, 1/4W
R577	RT1022214	Carbon, 220Ω, ±10%, 1/4W
R578	RT1010114	Carbon, 100Ω, ±10%, 1/4W
		CAPACITORS
C551	DD1615001	Ceramic, 15pF, ±10%, SL
C552	DF1668301	Mylar, 0.068μF, ±10%
C553	DF1740301	Mylar, 0.04μF, ±20%
C554	EA1060169	Elect., 10μF, 16V
C555	DK1840302	Ceramic, 0.04μF, +100%, -0%
C556	DK1810402	Ceramic, 0.1μF, +100%, -0%
C558	DK1810402	Ceramic, 1μF, +100%, -0%
C559	EA1060169	Elect., 10μF, 16V
C560-C561	DK1710301	Ceramic, 0.01μF, ±20%
C562	DK1840302	Ceramic, 0.04μF, +80%, -20%
		SEMICONDUCTORS
H551	HT307331C	Transistor, 2SC733 Gr
H552-H553	HT3037210	Transistor, 2SC372
H554-H555	HD1000105	Diode, 1N60
H558	HF200300A	FET, 2SK30
H559-H561	HT3037210	Transistor, 2SC372
		MISCELLANEOUS
L551	LC2105001	Choke Coil, 1mH
J551-J555	YP1000094	Plug
J559-J566	YP1000094	Plug
J557	YP1000094	Plug
P400	YD2577004 (ZZ2577004)	P. C. Board P. C. Board Assembly

REF. DESIG.	MARANTZ PART NO.	DESCRIPTION
C757-C758	DF1710452	Mylar, 0.1 μ F, \pm 20%, 200V x 2
C759-C760	EA1060169	Elect., 10 μ F, 16V x 2
C761	EV2260061	Elect. 22 μ F, +40%, -20%, 6.3V x 2
C762	DF1710452	Mylar, 0.1 μ F, \pm 20%, 200V x 2
C763	DF1722452	Mylar, 0.22 μ F, \pm 20%, 100V x 2
SEMICONDUCTORS		
H751	HK064019A	Transistor, 2SA640 (M) or (L) x 2
H753	HT309451Q	Transistor, 2SC945 (Q) x 2
H754-H755	HT307351B	Transistor, 2SC735 (O) x 2
H756	HK060719B	Transistor, 2SA607, 2SC960, x 2
H758	HK060719B	Transistor, 2SC960, 2SA607, x 2
H760	HT309841B	Transistor, 2SC984 (B) x 2
H761	HD2000307	Diode, SM-150-01 x 2
H762-H763	HD3002009	Diode, BZ-150 x 2
H764-H765	HD3002309	Diode, WZ-071 x 2
H766-H767	HT105621C	Transistor, 2SA562 (Y) x 2
H768-H769	HH0000812	Thermistor, 21D28, 150 Ω , \pm 15% 25 $^{\circ}$ C x 2
MISCELLANEOUS		
L751	LC2102001	Choke Coil, 2 μ H x 2
J751-J761	YP1000091	Plug x 2
P800	YD2818012 (ZZ2818012)	P. C. Board for Power Supply P. C. Board Assembly
RESISTORS		
R802	RC1033212	Solid, 3.3K Ω , 10%, 1/2W
R803	RC1010012	Solid, 10 Ω , 10%, 1/2W
R804	RC1010012	Solid, 10 Ω , 10%, 1/2W
R805	RT1047214	Carbon, 4.7K Ω , 10%, 1/4W
R806	RT1015214	Carbon, 1.5K Ω , 10%, 1/4W
R807	RC1039212	Solid, 3.9K Ω , 10%, 1/2W
R808	RT1027314	Carbon, 27K Ω , 10%, 1/4W
R809	RA0502013	Trimmer, 4.7K Ω , (B), 0.15W
R810	RT1056214	Carbon, 5.6K Ω , 10%, 1/4W
R811-R812	RC1056212	Solid, 5.6K Ω , 10%, 1/2W
R813	RT1022314	Carbon, 22K Ω , 10%, 1/4W
R814	RT1047214	Carbon, 4.7K Ω , 10%, 1/4W
R815	RT1039314	Carbon, 39K Ω , 10%, 1/4W
R816	RT1039414	Carbon, 390K Ω , 10%, 1/4W
R817	RT1039314	Carbon, 39K Ω , 10%, 1/4W
R818	RJ1047102	Carbon, 470 Ω , 10%, 2W
CAPACITORS		
C801	EB4770631	Elect., 470 μ F, +100%, -10%, 63V
C802	EA3370509	Elect., 330 μ F, +100%, -10%, 50V
C803	EA4770169	Elect., 470 μ F, +100%, -10%, 16V
C804	EA3370509	Elect., 330 μ F, +100%, -10%, 50V
C805	EA3350509	Elect., 3.3 μ F, +100%, -10%, 35V
C806	EA1060509	Elect., 10 μ F, +100%, -10%, 50V
C807	EA2270109	Elect., 220 μ F, +100%, -10%, 16V
C808-C809	DK1810351	Ceramic, 0.01 +100%, -10%

	MARANTZ PART NO.	DESCRIPTION
	EA4760169	Elect., 47 μ F, +100%, -10%, 16V
02	HD2000413	SEMICONDUCTORS Diode, SIB-01-02
	HT403154A	Transistor, 2SD315 (C. D. E. F)
	HD3002109	Diode, BZ-140 (14V 1W)
	HT306965A	Transistor, 2SC696
	HT307341C	Transistor, 2SC734 (Y)
	HD3002309	Diode, WZ-071 (7.1V \pm 0.4V 0.5W)
	HT309452A	Transistor, 2SC945 R or Q
10	HT312133A	Transistor, 2SC1213A (A, B or C)
13	HD2000413	Diode, SIB-01-02
	LY2024004	MISCELLANEOUS Choke Coil, 24VDC
	LY 20240100	
5	YP1000091	Plug
2	YP1000091	Plug
	HD2000510	SEMICONDUCTORS Diode, 5B2
	HD1000105	Diode, 1N60
	LF1120023	TRANSFORMERS Ant. Coil, AM Ant.
	LB3007528	Balun Coil, FM 300 Ω \rightarrow 750 Ω ,,,
	LC1302001	Choke Coil, 3 μ H
	TS6050201	Power Transf.
	LC1302001	Choke Coil, 3 μ H
	LC1302001	Choke Coil, 3 μ H
	IM1104203	MISCELLANEOUS AM/FM Signal Meter
	IN1006301	Stereo Lamp, 6.3V, 0.04A
	IN1006301	Stereo Lamp, 6.3V, 0.04A
08	IN1006301	Function Illumination Lamp, 6.3V, 0.04A
	IN1008018	Dial Pointer Illumination Lamp, 8V, 0.08A
16	IN1008007	Dial Pointer Illumination Lamp, 8V, 0.2A
	IM1104202	FM Tuning Meter
	SS0202017	FM Ant. Attenuator Switch
	SR0805016	Function Switch
	SP0201007	Power Supply Push Switch
	SP0402003	Tape Mon., Mono Push Switch
	SP0402004	Main, Remote Spk, Push Switch
7	YP1000097	Main In/Pre Out Plug
	YJ0100065	Dubbing Out Jack
	YJ0100055	Dubbing In Jack

REF. DESIG.	MARANTZ PART NO.	DESCRIPTION
J010	YJ0100055	Headphone Jack
J011	YJ0800012	Fuse Holder Socket
J013	YJ0400018	AC Outlet Jack
J014-J017	YJ0500013	Power Transistor Socket
J018	YL0106004	Terminal for AC Line Voltage Select
J019	YT0101003	Ground Terminal
J021-J027	YP1000094	Plug
J028	YJ0800013	Meter Illumination Socket
J029-J034	YJ0800013	Dial Illumination Socket
J035	YL0104001	4P Terminal
J036-J037	YL0107001	7P Terminal
J038	YL0107005	7P Terminal
J039	YL0102003	2P Terminal
J040	YJ0500017	Transistor Socket (For TO-66)
J041	YP1000094	Plug
J043	YL102003	2P Terminal
F001	FS1030003	Fuse
W001	YC0240010	AC Cord
W002-W003	YB0007001	Connective Cord
W004	YB0027001	Connective Cord
W005	YW2819001	Wire Material
W006	YX2819001	Wire Material
		RESISTORS
R001	RC1008212	Solid, 8.2 Ω , \pm 10%, 1/2W
R002-R003	RC1068012	Solid, 68 Ω , \pm 10%, 1/2W
R004	RK0254002	Variable, 250K Ω , (B)
R005	RM0254020	Variable, 250K Ω (MN)
R006	RM0254021	Variable, 250K Ω (A)
R007-R008	RT1047214	Carbon, 4.7K Ω , \pm 10%, 1/4W
R009-R010	RJ1022202	Carbon, 2.2K Ω , \pm 10%, 2W
R011	RC1020012	Solid, 20 Ω , \pm 10%, 1/2W
R012	RC1010212	Solid, 1K Ω , \pm 10%, 1/2W
R013	GS1015105	Wire Wound, 150 Ω , \pm 10%, 5W
R014	GT0522501	Carbon, 2.2M Ω , \pm 5%, 1W
R015-R016	RT1010214	Carbon, 1K Ω , \pm 10%, 1/4W
R017-R018	GS1010103	Wire Wound, 100 Ω , \pm 10%, 3W
R019-R020	RJ1047002	Carbon, 47 Ω , \pm 10%, 2W
R024	RT1022214	Carbon, 2.2K Ω , \pm 10%, 1/4W
R022	RA0103018	Trimmer, 10K Ω , B
		CAPACITORS
C003	DK1710301	Ceramic, 0.01 μ F \pm 20%, 50V, YY
C004	DO0756380	Oil Paper, 0.056 μ F, \pm 20%, 800VAC
C005-C006	DO0720350	Oil Paper, 0.02 μ F, \pm 20%, 600VDC
C007-C008	EC9080551	Elect., 9000 μ F, +50%, -4%, 55WV
C009	EA3360109	Elect., 33 μ F, 10V
C010-C011	DK1710301	Ceramic, 0.01 μ F, \pm 20%, 50V, YY
C013	EA4750359	Elect., 4.7 μ F, 35V
		RESISTORS
R023	RT1082214	Carbon, 8.2K Ω , \pm 10%, 1/4W
R021	RC1018012	Solid, 18 Ω , \pm 10%, 1/2W